

## Purpose

The RT8295A is a high-efficiency current mode synchronous step-down regulator that can deliver up to 2A output current from a wide input voltage range of 4.5V to 23V. This document explains the function and use of the RT8295A evaluation board (EVB) and provides information to enable operation and modification of the evaluation board and circuit to suit individual requirements.

## Table of Contents

<i>Purpose</i> .....	1
<i>Introduction</i> .....	2
<i>General Product Information</i> .....	2
<i>Key Performance Summary Table</i> .....	3
<i>Bench Test Setup Conditions</i> .....	4
<i>Headers Description and Placement</i> .....	4
<i>Test Points</i> .....	4
<i>Power-up &amp; Measurement Procedure</i> .....	5
<i>Output Voltage Setting</i> .....	5
<i>Schematic, Bill of Materials and Board Layout</i> .....	6
<i>EVB Schematic Diagram</i> .....	6
<i>Bill of Materials</i> .....	7
<i>EVB Layout</i> .....	8
<i>Other Technical Information</i> .....	錯誤! 尚未定義書籤。

## ***Introduction***

### ***General Product Information***

#### **General Description**

The RT8295A is a high efficiency, monolithic synchronous step-down DC/DC converter that can deliver up to 2A output current from a 4.5V to 23V input supply. The RT8295A's current mode architecture and external compensation allow the transient response to be optimized over a wide range of loads and output capacitors. Cycle-by-cycle current limit provides protection against shorted outputs and soft-start eliminates input current surge during start-up. The RT8295A also provides output under voltage protection and thermal shutdown protection. The low current (<3 $\mu$ A) shutdown mode provides output disconnection, enabling easy power management in battery-powered systems. The RT8295A is available in an SOP-8 (Exposed Pad) package.

#### **Features**

- $\pm 1.5\%$  High Accuracy Feedback Voltage
- 4.5V to 23V Input Voltage Range
- 2A Output Current
- Integrated N-MOSFET Switches
- Current Mode Control
- PWM Frequency Operation : 340kHz
- Output Adjustable from 0.8V to 20V
- Up to 95% Efficiency
- Programmable Soft-Start
- Stable with Low-ESR Ceramic Output Capacitors
- Cycle-by-Cycle Over Current Protection
- Input Under Voltage Lockout
- Output Under Voltage Protection
- Thermal Shutdown Protection

*Key Performance Summary Table*

<b>Key features</b>	<b>Evaluation board number: PCB004_V1</b>
Default Input Voltage	12V
Max Output Current	2A
Default Output Voltage	3.3V
Default Marking & Package Type	RT8295AHZSP, PSOP-8 (Exposed Pad)
Operation Frequency	Steady 340kHz at PWM
Other Key Features	4.5V to 23V Input Voltage Range Programmable Soft-Start PSM/ PWM Auto Switched
Protection	Output Under-Voltage Protection (hiccup mode): Cycle-by-cycle Current Limit Thermal Shutdown

## Bench Test Setup Conditions

### Headers Description and Placement

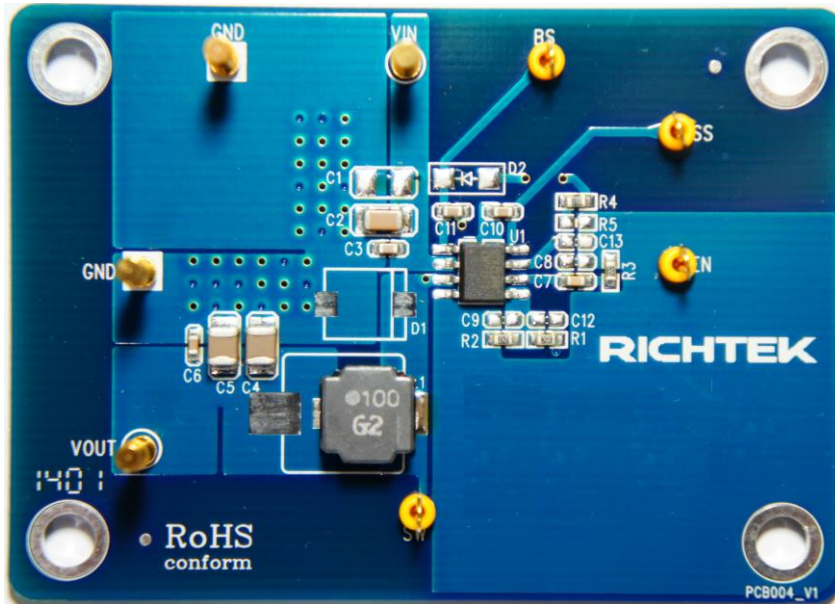

Please carefully inspect the EVB IC and external components, comparing them to the following Bill of Materials, to ensure that all components are installed and undamaged. If any components are missing or damaged during transportation, please contact the distributor or send e-mail to [evb\\_service@richtek.com](mailto:evb_service@richtek.com).

### Test Points

The EVB is provided with the test points and pin names listed in the table below.

Test point/ Pin name	Signal	Comment (expected waveforms or voltage levels on test points)
VIN	Input voltage	Input voltage range= 4.5V to 23V
VOUT	Output voltage	Default output voltage = 3.3V Output voltage range= 0.8V to 20V (see " Output Voltage Setting" section for changing output voltage level)
SW	Switching node test point	SW waveform
EN	Enable test point	Enable signal. EN is automatically pulled high (by R4) to enable operation. Connect EN low to disable operation.
BS	Boot strap supply test point	Floating supply voltage for the high-side N-MOSFET switch
SS	Soft-start control test point	Soft start waveform
GND	Ground	Ground

### *Power-up & Measurement Procedure*

1. Apply a 12V nominal input power supply ( $4.5V < V_{IN} < 23V$ ) to the VIN and GND terminals.
2. The EN voltage is pulled to logic high by R4 (100k $\Omega$  to VIN) to enable operation. Drive EN high (>2.7V) to enable operation or low (<0.4V) to disable operation.
3. Verify the output voltage (approximately 3.3V) between VOUT and GND.
4. Connect an external load up to 2A to the VOUT and GND terminals and verify the output voltage and current.

### *Output Voltage Setting*

Set the output voltage with the resistive divider (R1, R2) between VOUT and GND with the midpoint connected to FB. The output is set by the following formula:

$$V_{OUT} = 0.8 \times \left(1 + \frac{R1}{R2}\right)$$

The installed VOUT capacitors (C4, C5) are 22 $\mu$ F, 16V X5R ceramic types. Do not exceed their operating voltage range and consider their voltage coefficient (capacitance vs. bias voltage) and ensure that the capacitance is sufficient to maintain stability and provide sufficient transient response for your application. This can be verified by checking the output transient response as described in the RT8295 IC datasheet.

## Schematic, Bill of Materials and Board Layout

### EVB Schematic Diagram

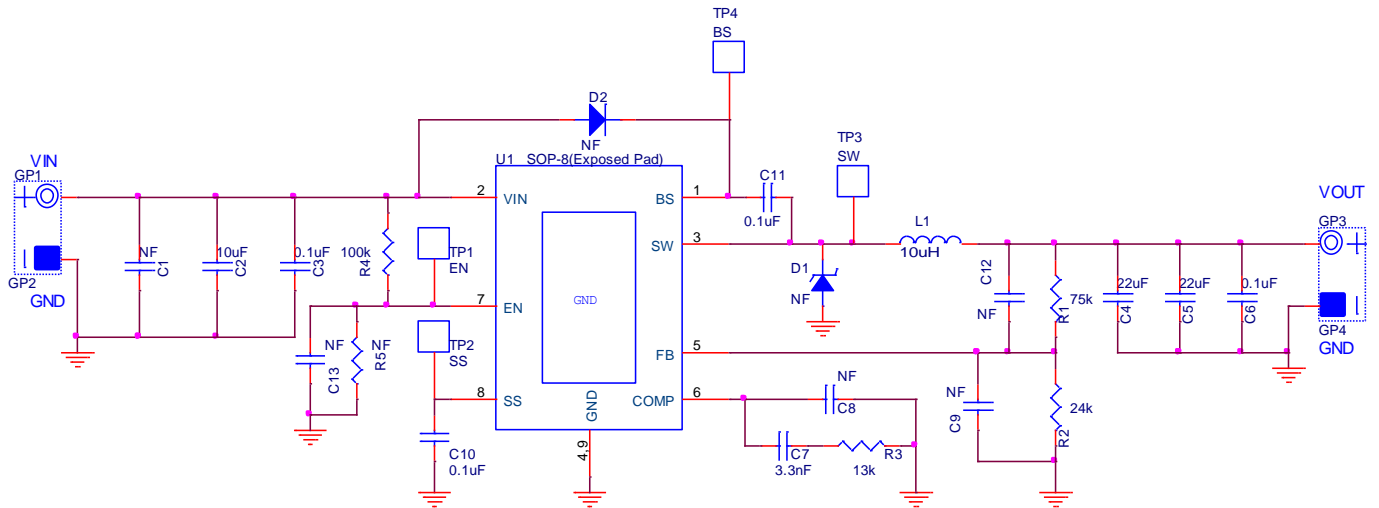

C2: 10 $\mu$ F/50V/X5R, 1206, TDK C3216X5R1H106K

C4, C5: 22 $\mu$ F/16V/X5R, 1210, Murata GRM32ER61C226K

L1: 10 $\mu$ H TAIYO YUDEN NR8040T100M, DCR=34m $\Omega$

*Bill of Materials*

Reference	Qty	Part number	Description	Package	Manufacture
U1	1	RT8295AHZSP	DC-DC Converter	PSOP-8	Richtek
C2	1	C3216X5R1H106K160AB	10uF/±10%/50V/X5R Ceramic Capacitor	1206	TDK
C4, C5	2	GRM32ER61C226KE20#	22uF/±10%/16V/X5R Ceramic Capacitor	1210	Murata
C7	1	0603B332K500	3.3nF/±10%/50V/X7R Ceramic Capacitor	0603	WALSIN
C3, C6, C10,C11	4	C1608X7R1H104K080AA	0.1uF/±10%/50V/X7R Ceramic Capacitor	0603	TDK
C1,C8,C9,C12,C13	0		Not Installed	0603	
L1	1	NR8040T100M	10uH/3.1A/±20%, DCR=34mΩ, Inductor	8mmx8mmx4mm	TAIYO YUDEN
R1	1		75kΩ/±1%, Resistor	0603	
R2	1		24kΩ/±1%, Resistor	0603	
R3	1		13kΩ/±1%, Resistor	0603	
R4	1		100kΩ/±1%, Resistor	0603	
R5	0		Not Installed	0603	
D1, D2	0		Not Installed		
TP	4		Test Pin		
GP	4		Golden Pin		

*EVB Layout*

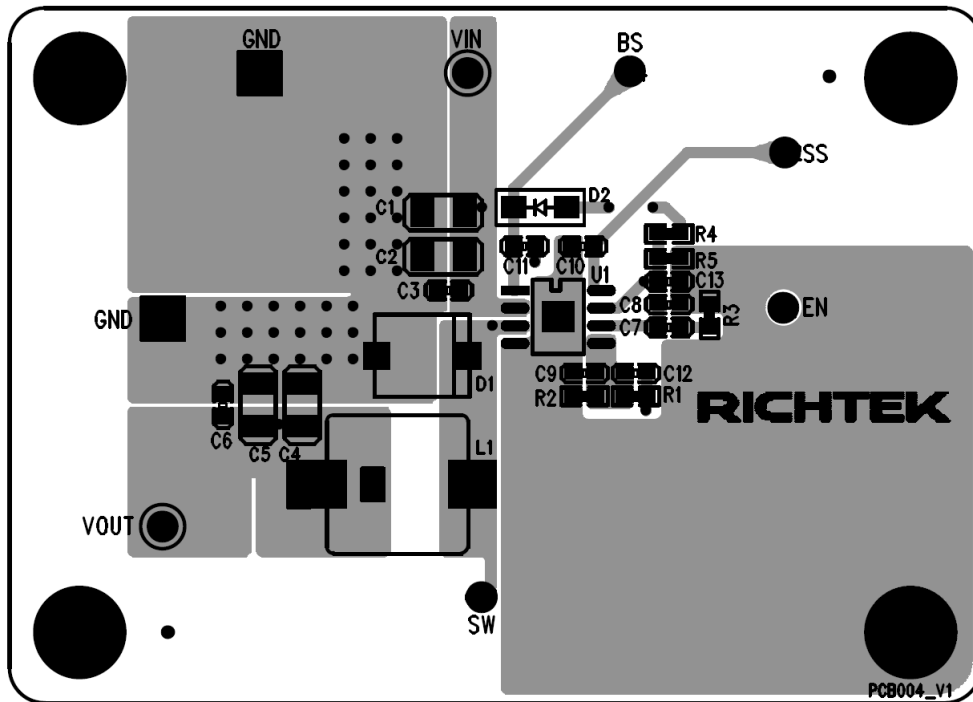

Top View (1<sup>st</sup> layer)

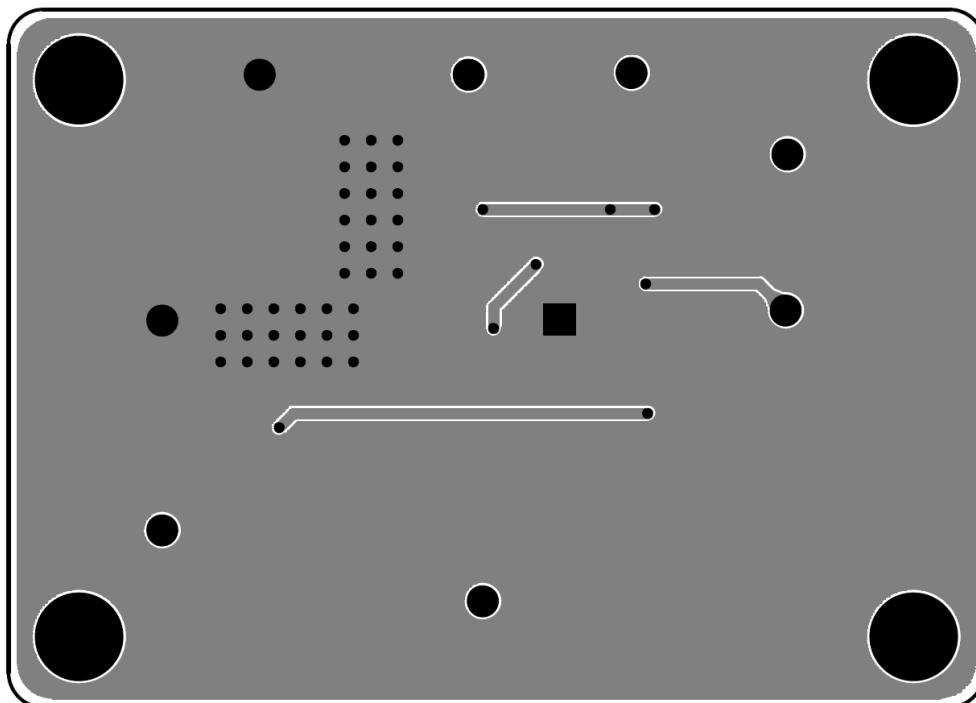

Bottom View (2<sup>nd</sup> Layer)



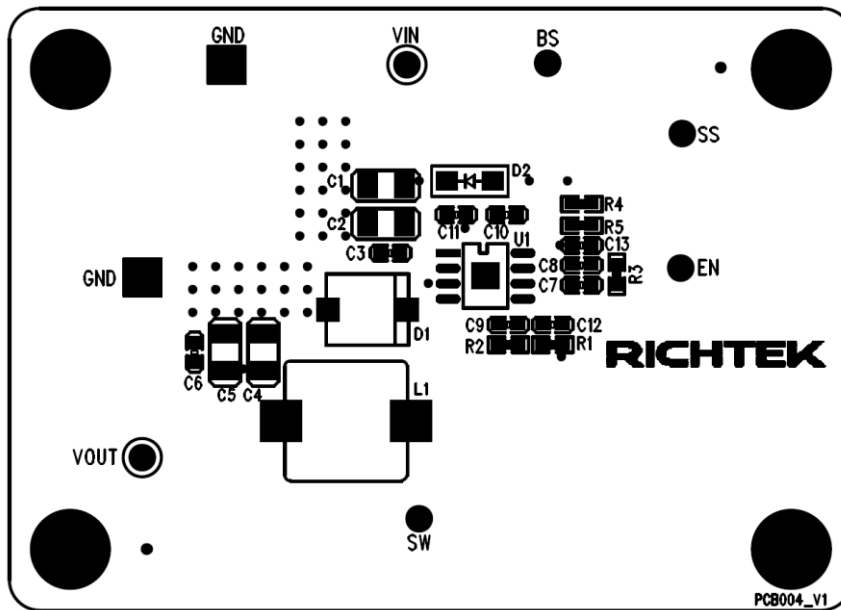

Component Placement Guide—Component Side (1<sup>st</sup> layer)

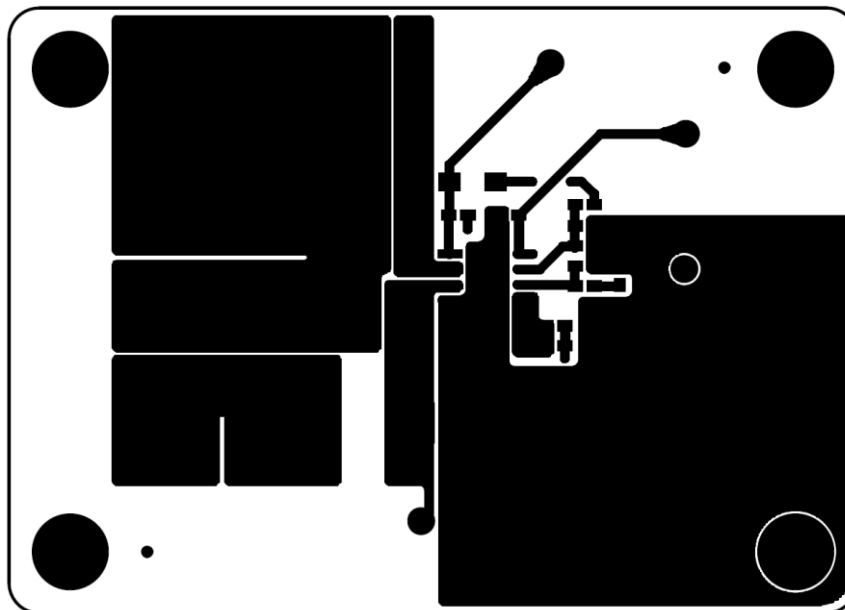

PCB Layout—Component Side (1<sup>st</sup> Layer)

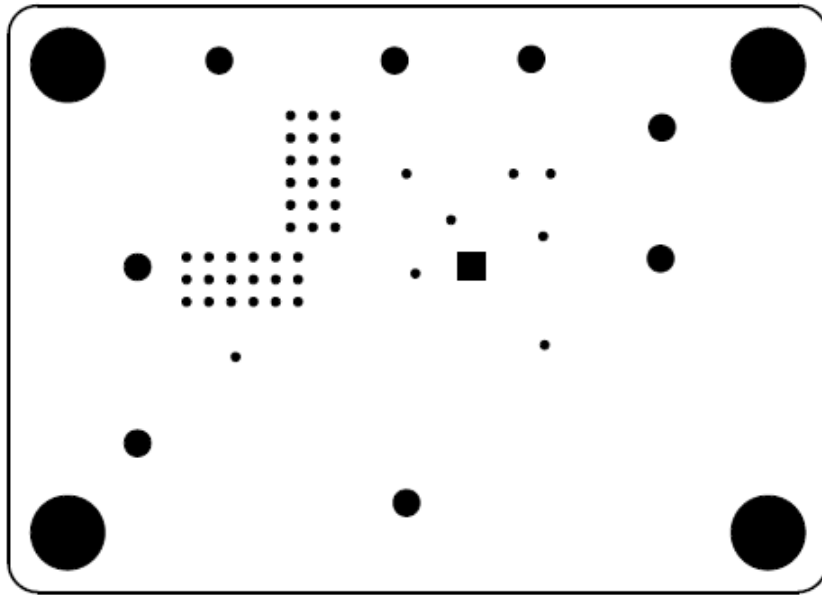

Component Placement Guide—Bottom Side (2<sup>nd</sup> layer)

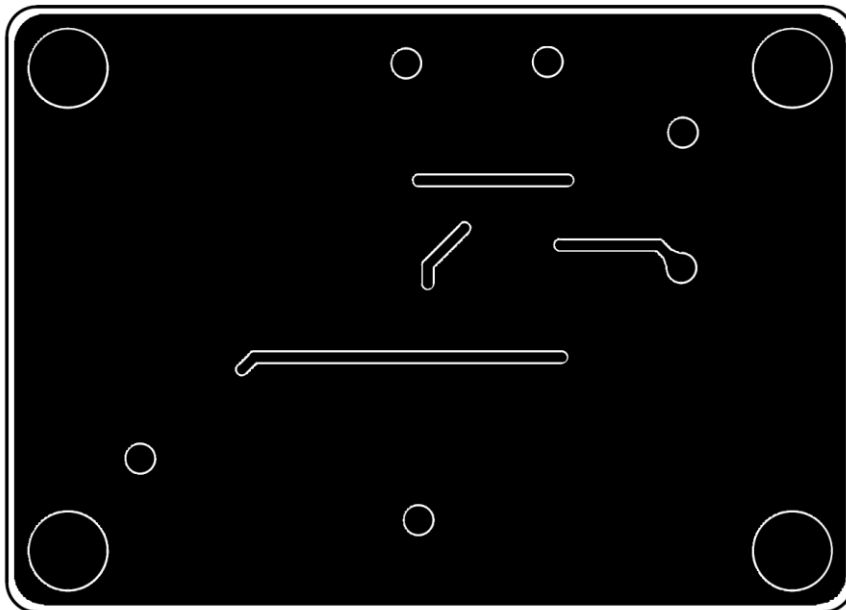

PCB Layout—Bottom Side (2<sup>nd</sup> layer)

### ***More Information***

For more information, please find the related datasheet or application notes from Richtek website <http://www.richtek.com>.

### ***Important Notice for Richtek Evaluation Board***

THIS DOCUMENT IS FOR REFERENCE ONLY, NOTHING CONTAINED IN THIS DOCUMENT SHALL BE CONSTRUED AS RICHTEK'S WARRANTY, EXPRESS OR IMPLIED, UNDER CONTRACT, TORT OR STATUTORY, WITH RESPECT TO THE PRESENTATION HEREIN. IN NO EVENT SHALL RICHTEK BE LIABLE TO BUYER OR USER FOR ANY AND ALL DAMAGES INCLUDING WITHOUT LIMITATION TO DIRECT, INDIRECT, SPECIAL, PUNITIVE OR CONSEQUENTIAL DAMAGES.