

FEATURES

Excellent Video Specifications ($R_L = 150 \Omega$, $G = +2$)
 Gain Flatness 0.1 dB to 100 MHz
 0.01% Differential Gain Error
 0.025° Differential Phase Error

Low Power

5.5 mA Max Power Supply Current (55 mW)

High Speed and Fast Settling

880 MHz, -3 dB Bandwidth ($G = +1$)
 440 MHz, -3 dB Bandwidth ($G = +2$)
 1200 V/ μ s Slew Rate
 10 ns Settling Time to 0.1%

Low Distortion

-65 dBc THD, $f_c = 5$ MHz
 33 dBm 3rd Order Intercept, $F_1 = 10$ MHz
 -66 dB SFDR, $f = 5$ MHz

High Output Drive

70 mA Output Current
 Drives Up to Four Back-Terminated Loads (75 Ω Each)
 While Maintaining Good Differential Gain/Phase
 Performance (0.05%/0.25°)

APPLICATIONS

A-to-D Driver
 Video Line Driver
 Professional Cameras
 Video Switchers
 Special Effects
 RF Receivers

PRODUCT DESCRIPTION

The AD8001 is a low power, high-speed amplifier designed to operate on ± 5 V supplies. The AD8001 features unique

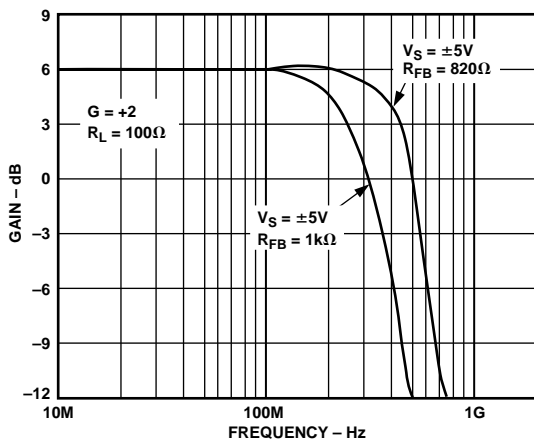

Figure 1. Frequency Response of AD8001

REV. C

Information furnished by Analog Devices is believed to be accurate and reliable. However, no responsibility is assumed by Analog Devices for its use, nor for any infringements of patents or other rights of third parties which may result from its use. No license is granted by implication or otherwise under any patent or patent rights of Analog Devices.

FUNCTIONAL BLOCK DIAGRAMS

8-Lead DIP (N-8, Q-8)
and SOIC (SO-8)

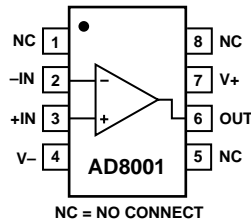

5-Lead
SOT-23-5

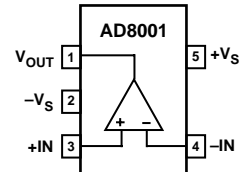

transimpedance linearization circuitry. This allows it to drive video loads with excellent differential gain and phase performance on only 50 mW of power. The AD8001 is a current feedback amplifier and features gain flatness of 0.1 dB to 100 MHz while offering differential gain and phase error of 0.01% and 0.025°. This makes the AD8001 ideal for professional video electronics such as cameras and video switchers. Additionally, the AD8001's low distortion and fast settling make it ideal for buffer high-speed A-to-D converters.

The AD8001 offers low power of 5.5 mA max ($V_S = \pm 5$ V) and can run on a single +12 V power supply, while being capable of delivering over 70 mA of load current. These features make this amplifier ideal for portable and battery-powered applications where size and power are critical.

The outstanding bandwidth of 800 MHz along with 1200 V/ μ s of slew rate make the AD8001 useful in many general purpose high-speed applications where dual power supplies of up to ± 6 V and single supplies from 6 V to 12 V are needed. The AD8001 is available in the industrial temperature range of -40°C to $+85^\circ\text{C}$.

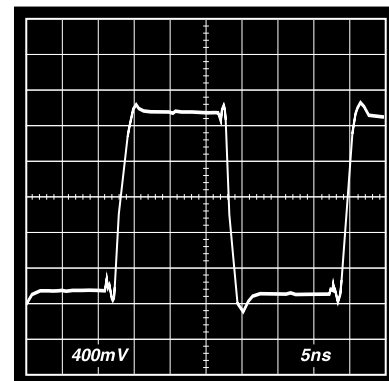

Figure 2. Transient Response of AD8001; 2 V Step, $G = +2$

AD8001—SPECIFICATIONS (@ $T_A = +25^\circ\text{C}$, $V_S = \pm 5\text{ V}$, $R_L = 100\ \Omega$, unless otherwise noted)

| Model | Conditions | AD8001A | | | Units |
|--|---|--|-------|-----------|------------------------------|
| | | Min | Typ | Max | |
| DYNAMIC PERFORMANCE | | | | | |
| -3 dB Small Signal Bandwidth, | N Package | $G = +2$, < 0.1 dB Peaking, $R_F = 750\ \Omega$ | 350 | 440 | MHz |
| | R Package | $G = +1$, < 1 dB Peaking, $R_F = 1\ \text{k}\Omega$ | 650 | 880 | MHz |
| Bandwidth for 0.1 dB Flatness | R Package | $G = +2$, < 0.1 dB Peaking, $R_F = 681\ \Omega$ | 350 | 440 | MHz |
| | RT Package | $G = +1$, < 0.1 dB Peaking, $R_F = 845\ \Omega$ | 575 | 715 | MHz |
| Slew Rate | RT Package | $G = +2$, < 0.1 dB Peaking, $R_F = 768\ \Omega$ | 300 | 380 | MHz |
| | N Package | $G = +1$, < 0.1 dB Peaking, $R_F = 1\ \text{k}\Omega$ | 575 | 795 | MHz |
| | R Package | $G = +2$, $R_F = 750\ \Omega$ | 85 | 110 | MHz |
| Settling Time to 0.1% Rise and Fall Time | R Package | $G = +2$, $R_F = 681\ \Omega$ | 100 | 125 | MHz |
| | RT Package | $G = +2$, $R_F = 768\ \Omega$ | 120 | 145 | MHz |
| Slew Rate | | $G = +2$, $V_O = 2\ \text{V Step}$ | 800 | 1000 | V/ μs |
| | | $G = -1$, $V_O = 2\ \text{V Step}$ | 960 | 1200 | V/ μs |
| NOISE/HARMONIC PERFORMANCE | | | | | |
| Total Harmonic Distortion | $f_C = 5\ \text{MHz}$, $V_O = 2\ \text{V p-p}$ $G = +2$, $R_L = 100\ \Omega$ | | -65 | | dBc |
| Input Voltage Noise | $f = 10\ \text{kHz}$ | | 2.0 | | nV/ $\sqrt{\text{Hz}}$ |
| Input Current Noise | $f = 10\ \text{kHz}$, +In | | 2.0 | | pA/ $\sqrt{\text{Hz}}$ |
| | -In | | 18 | | pA/ $\sqrt{\text{Hz}}$ |
| Differential Gain Error | NTSC, $G = +2$, $R_L = 150\ \Omega$ | | 0.01 | 0.025 | % |
| Differential Phase Error | NTSC, $G = +2$, $R_L = 150\ \Omega$ | | 0.025 | 0.04 | Degree |
| Third Order Intercept | $f = 10\ \text{MHz}$ | | 33 | | dBm |
| 1 dB Gain Compression | $f = 10\ \text{MHz}$ | | 14 | | dBm |
| SFDR | $f = 5\ \text{MHz}$ | | -66 | | dB |
| DC PERFORMANCE | | | | | |
| Input Offset Voltage | $T_{\text{MIN}}-T_{\text{MAX}}$ | | 2.0 | 5.5 | mV |
| Offset Drift | | | 2.0 | 9.0 | mV |
| | | | 10 | | $\mu\text{V}/^\circ\text{C}$ |
| -Input Bias Current | $T_{\text{MIN}}-T_{\text{MAX}}$ | | 5.0 | 25 | $\pm\mu\text{A}$ |
| +Input Bias Current | | | | 35 | $\pm\mu\text{A}$ |
| | | | 3.0 | 6.0 | $\pm\mu\text{A}$ |
| Open Loop Transresistance | $T_{\text{MIN}}-T_{\text{MAX}}$ $V_O = \pm 2.5\ \text{V}$ | 250 | 900 | 10 | $\pm\mu\text{A}$ |
| | $T_{\text{MIN}}-T_{\text{MAX}}$ | 175 | | | k Ω |
| INPUT CHARACTERISTICS | | | | | |
| Input Resistance | +Input | | 10 | | M Ω |
| | -Input | | 50 | | Ω |
| Input Capacitance | +Input | | 1.5 | | pF |
| Input Common-Mode Voltage Range | | | 3.2 | | $\pm\text{V}$ |
| Common-Mode Rejection Ratio | | | | | |
| Offset Voltage | $V_{\text{CM}} = \pm 2.5\ \text{V}$ | 50 | 54 | | dB |
| -Input Current | $V_{\text{CM}} = \pm 2.5\ \text{V}$, $T_{\text{MIN}}-T_{\text{MAX}}$ | | 0.3 | 1.0 | $\mu\text{A/V}$ |
| +Input Current | $V_{\text{CM}} = \pm 2.5\ \text{V}$, $T_{\text{MIN}}-T_{\text{MAX}}$ | | 0.2 | 0.7 | $\mu\text{A/V}$ |
| OUTPUT CHARACTERISTICS | | | | | |
| Output Voltage Swing | $R_L = 150\ \Omega$ | 2.7 | 3.1 | | $\pm\text{V}$ |
| Output Current | $R_L = 37.5\ \Omega$ | 50 | 70 | | mA |
| Short Circuit Current | | 85 | 110 | | mA |
| POWER SUPPLY | | | | | |
| Operating Range | | ± 3.0 | | ± 6.0 | V |
| Quiescent Current | $T_{\text{MIN}}-T_{\text{MAX}}$ | | 5.0 | 5.5 | mA |
| Power Supply Rejection Ratio | $+V_S = +4\ \text{V to } +6\ \text{V}$, $-V_S = -5\ \text{V}$ | 60 | 75 | | dB |
| | $-V_S = -4\ \text{V to } -6\ \text{V}$, $+V_S = +5\ \text{V}$ | 50 | 56 | | dB |
| -Input Current | $T_{\text{MIN}}-T_{\text{MAX}}$ | | 0.5 | 2.5 | $\mu\text{A/V}$ |
| +Input Current | $T_{\text{MIN}}-T_{\text{MAX}}$ | | 0.1 | 0.5 | $\mu\text{A/V}$ |

Specifications subject to change without notice.

ABSOLUTE MAXIMUM RATINGS¹

| | |
|---|-------------------------------|
| Supply Voltage | 12.6 V |
| Internal Power Dissipation ² | |
| Plastic DIP Package (N) | 1.3 W |
| Small Outline Package (R) | 0.9 W |
| SOT-23-5 Package (RT) | 0.5 W |
| Input Voltage (Common Mode) | $\pm V_S$ |
| Differential Input Voltage | ± 1.2 V |
| Output Short Circuit Duration | Observe Power Derating Curves |
| Storage Temperature Range N, R | -65°C to +125°C |
| Operating Temperature Range (A Grade) | -40°C to +85°C |
| Lead Temperature Range (Soldering 10 sec) | +300°C |

NOTES

¹Stresses above those listed under Absolute Maximum Ratings may cause permanent damage to the device. This is a stress rating only; functional operation of the device at these or any other conditions above those indicated in the operational section of this specification is not implied. Exposure to absolute maximum rating conditions for extended periods may affect device reliability.

²Specification is for device in free air:

8-Lead Plastic DIP Package: $\theta_{JA} = 90^\circ\text{C}/\text{W}$

8-Lead SOIC Package: $\theta_{JA} = 155^\circ\text{C}/\text{W}$

8-Lead Cerdip Package: $\theta_{JA} = 110^\circ\text{C}/\text{W}$

5-Lead SOT-23-5 Package: $\theta_{JA} = 260^\circ\text{C}/\text{W}$

MAXIMUM POWER DISSIPATION

The maximum power that can be safely dissipated by the AD8001 is limited by the associated rise in junction temperature. The maximum safe junction temperature for plastic encapsulated devices is determined by the glass transition temperature of the plastic, approximately +150°C. Exceeding this limit temporarily may cause a shift in parametric performance due to a change in the stresses exerted on the die by the package. Exceeding a junction temperature of +175°C for an extended period can result in device failure.

While the AD8001 is internally short circuit protected, this may not be sufficient to guarantee that the maximum junction temperature (+150°C) is not exceeded under all conditions. To ensure proper operation, it is necessary to observe the maximum power derating curves.

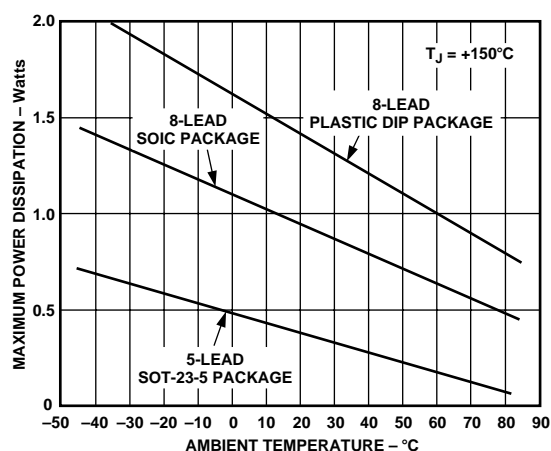

Figure 3. Plot of Maximum Power Dissipation vs. Temperature

ORDERING GUIDE

| Model | Temperature Range | Package Description | Package Option | Brand Code |
|------------------------------|-------------------|-------------------------------|----------------|------------|
| AD8001AN | -40°C to +85°C | 8-Lead Plastic DIP | N-8 | |
| AD8001AQ | -55°C to +125°C | 8-Lead Cerdip | Q-8 | |
| AD8001AR | -40°C to +85°C | 8-Lead SOIC | SO-8 | |
| AD8001AR-REEL | -40°C to +85°C | 13" Tape and REEL | SO-8 | |
| AD8001AR-REEL7 | -40°C to +85°C | 7" Tape and REEL | SO-8 | |
| AD8001ART-REEL | -40°C to +85°C | 13" Tape and REEL | RT-5 | HEA |
| AD8001ART-REEL7 | -40°C to +85°C | 7" Tape and REEL | RT-5 | HEA |
| AD8001ACHIPS | -40°C to +85°C | Die Form | | |
| 5962-9459301MPA ¹ | -55°C to +125°C | 8-Lead Cerdip | Q-8 | |
| AD8001R-EB+2 ² | | SOIC Evaluation Board, G = +2 | | |

NOTES

¹Standard Military Drawing Device.

²Refer to Evaluation Board section.

CAUTION

ESD (electrostatic discharge) sensitive device. Electrostatic charges as high as 4000 V readily accumulate on the human body and test equipment and can discharge without detection. Although the AD8001 features proprietary ESD protection circuitry, permanent damage may occur on devices subjected to high energy electrostatic discharges. Therefore, proper ESD precautions are recommended to avoid performance degradation or loss of functionality.



AD8001

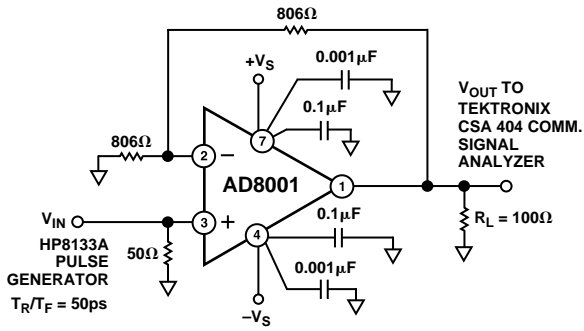

Figure 4. Test Circuit, Gain = +2

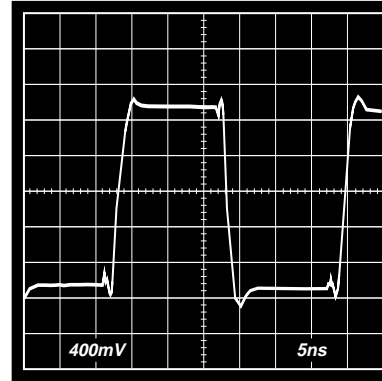

Figure 7. 2 V Step Response, G = +2

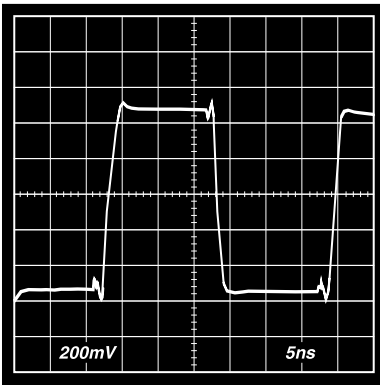

Figure 5. 1 V Step Response, G = +2

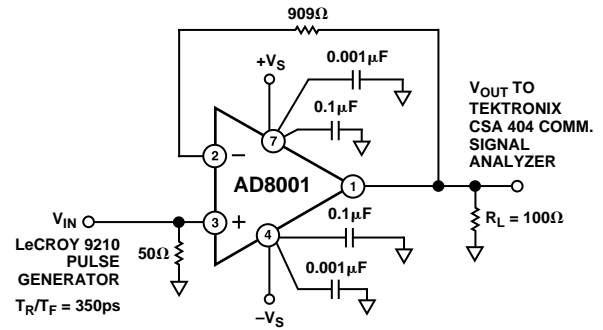

Figure 8. Test Circuit, Gain = +1

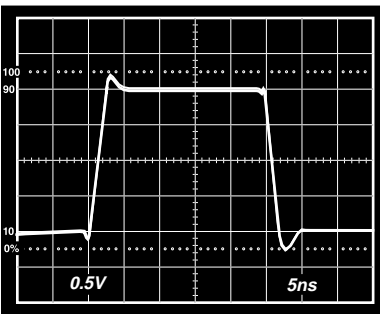

Figure 6. 2 V Step Response, G = +1

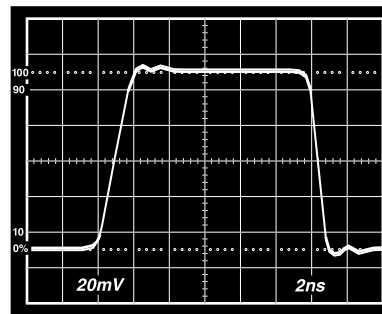

Figure 9. 100 mV Step Response, G = +1

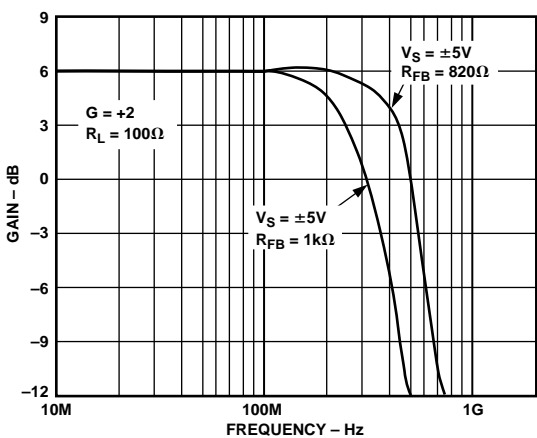

Figure 10. Frequency Response, $G = +2$

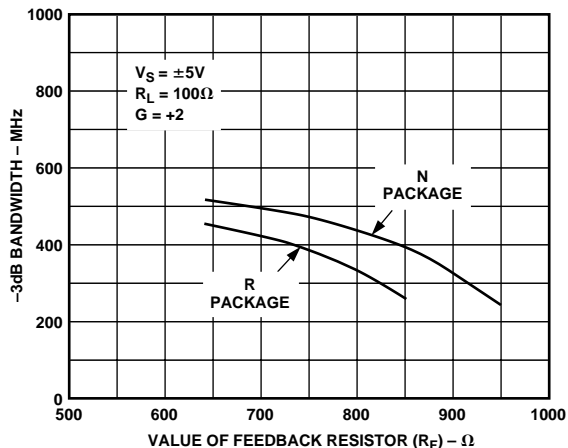

Figure 13. -3 dB Bandwidth vs. R_F

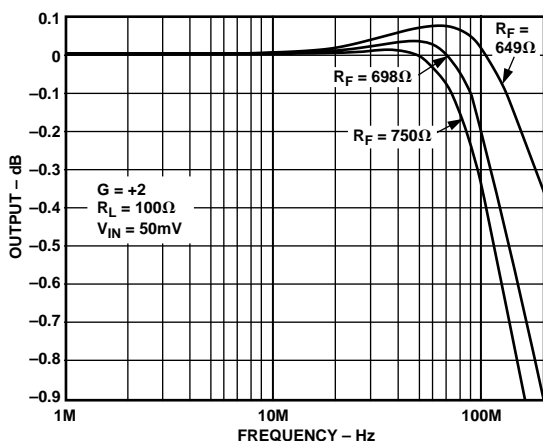

Figure 11. 0.1 dB Flatness, R Package (for N Package Add 50Ω to R_F)

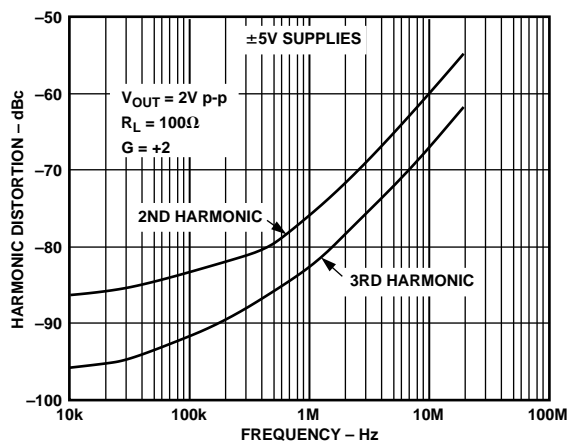

Figure 14. Distortion vs. Frequency, $R_L = 100 \Omega$

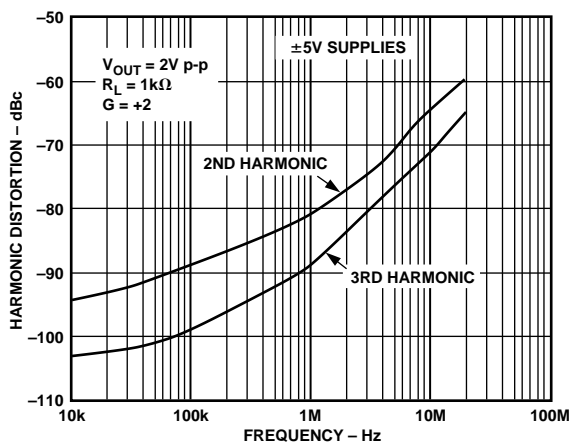

Figure 12. Distortion vs. Frequency, $R_L = 1 \text{ k}\Omega$

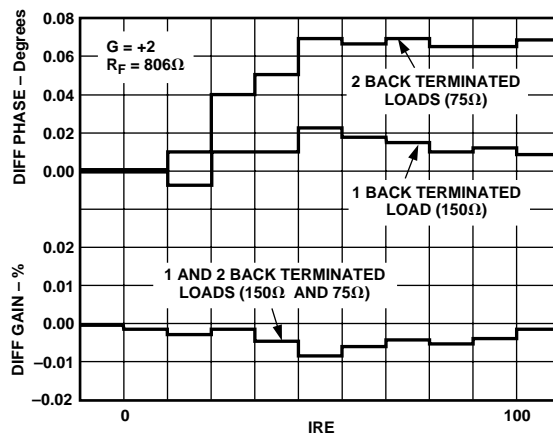

Figure 15. Differential Gain and Differential Phase

AD8001

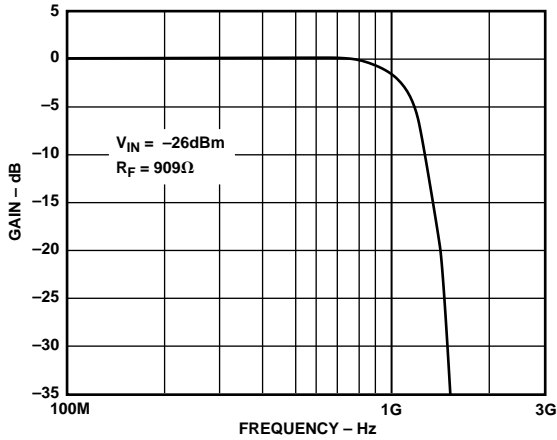

Figure 16. Frequency Response, $G = +1$

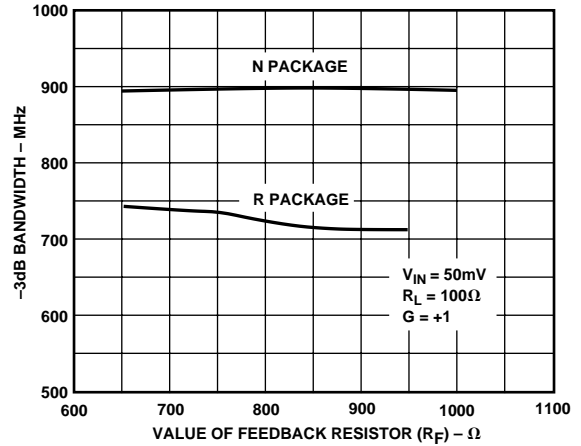

Figure 19. -3 dB Bandwidth vs. R_F , $G = +1$

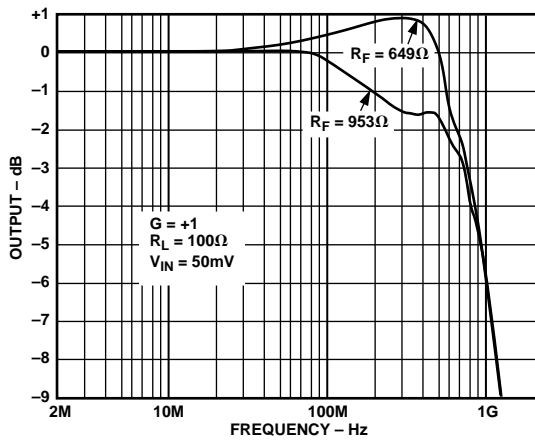

Figure 17. Flatness, R Package, $G = +1$ (for N Package Add 100Ω to R_F)

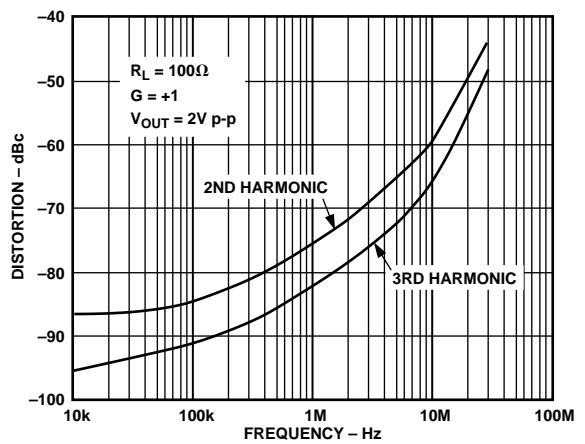

Figure 20. Distortion vs. Frequency, $R_L = 100\Omega$

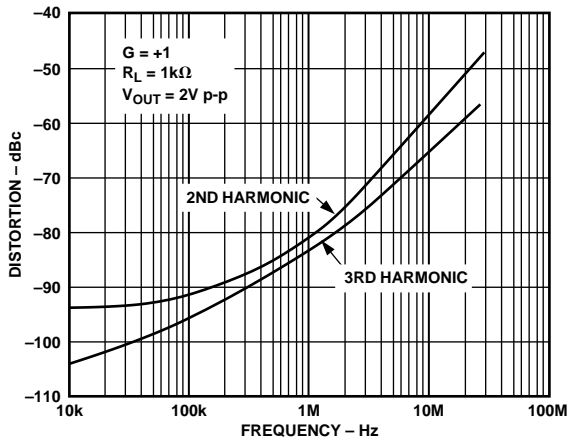

Figure 18. Distortion vs. Frequency, $R_L = 1\text{k}\Omega$

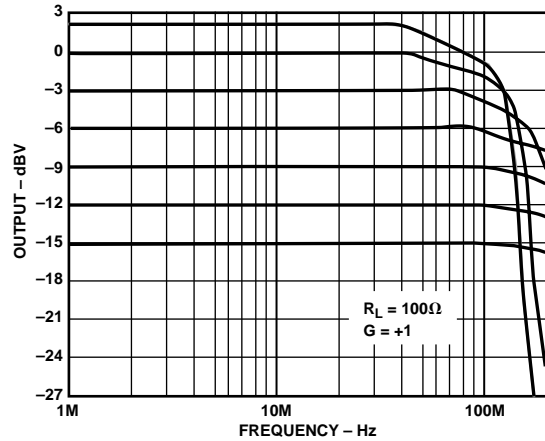

Figure 21. Large Signal Frequency Response, $G = +1$

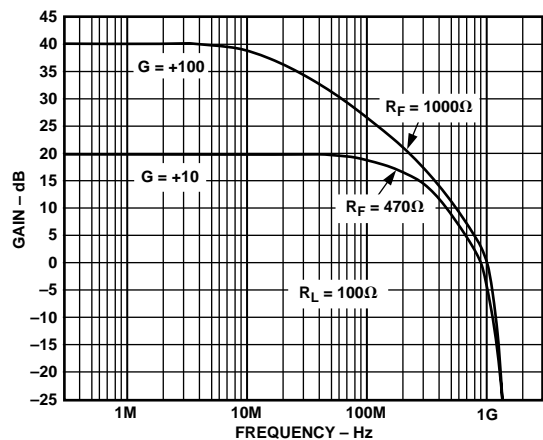

Figure 22. Frequency Response, $G = +10$, $G = +100$

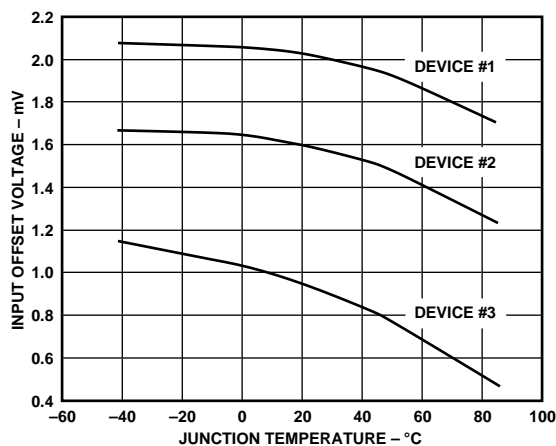

Figure 25. Input Offset vs. Temperature

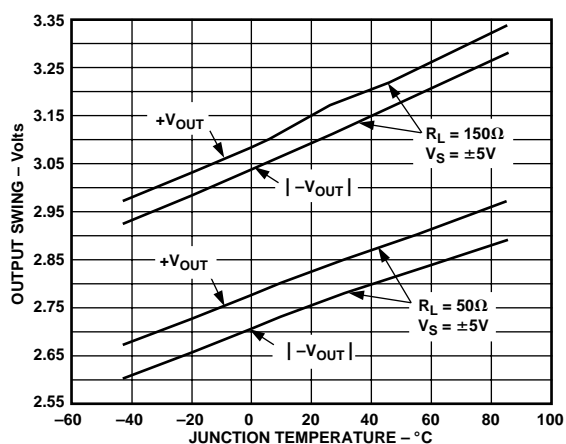

Figure 23. Output Swing vs. Temperature

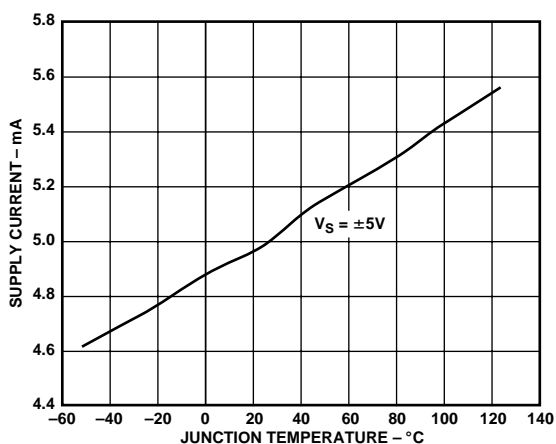

Figure 26. Supply Current vs. Temperature

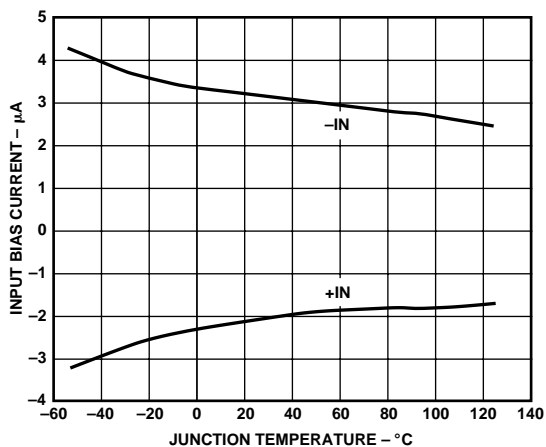

Figure 24. Input Bias Current vs. Temperature

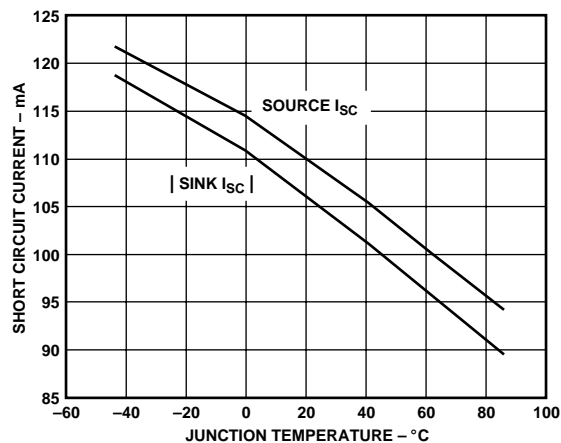

Figure 27. Short Circuit Current vs. Temperature

AD8001

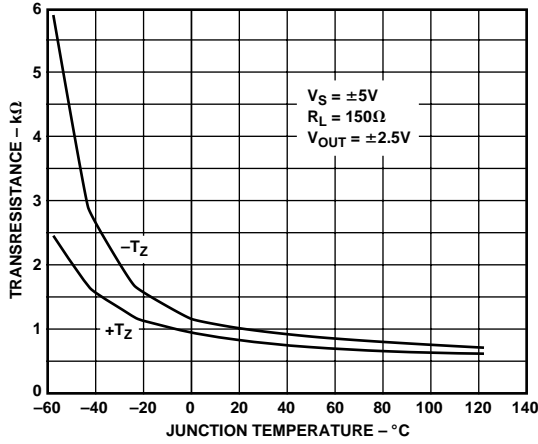

Figure 28. Transresistance vs. Temperature

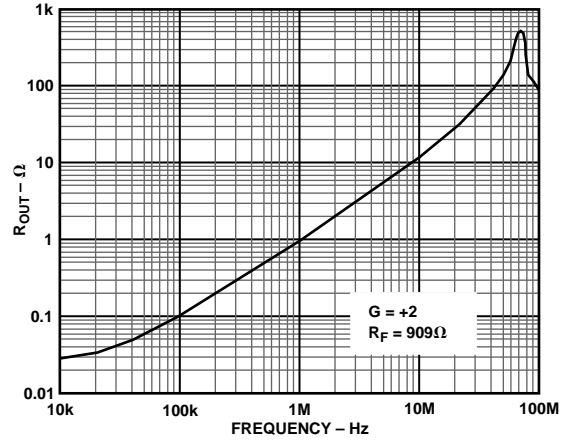

Figure 31. Output Resistance vs. Frequency

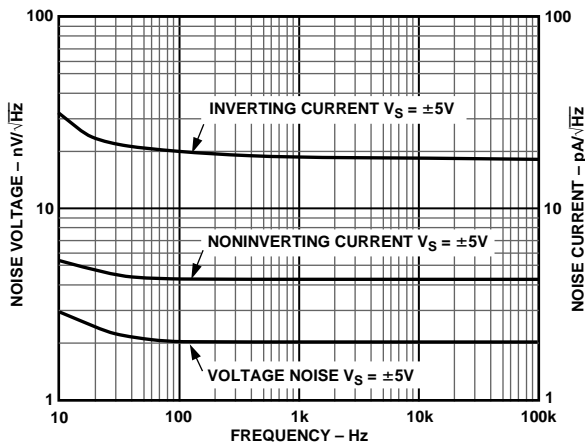

Figure 29. Noise vs. Frequency

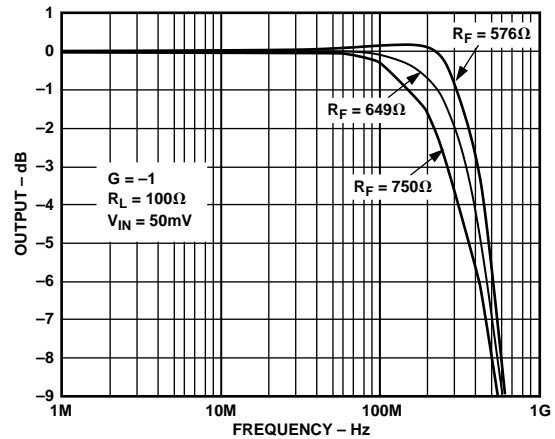

Figure 32. -3 dB Bandwidth vs. Frequency, $G = -1$

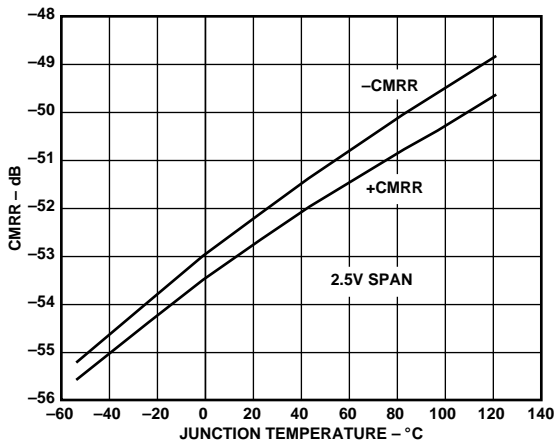

Figure 30. CMRR vs. Temperature

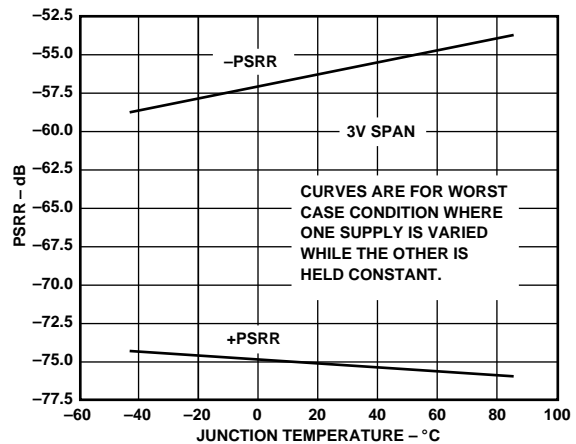

Figure 33. PSRR vs. Temperature

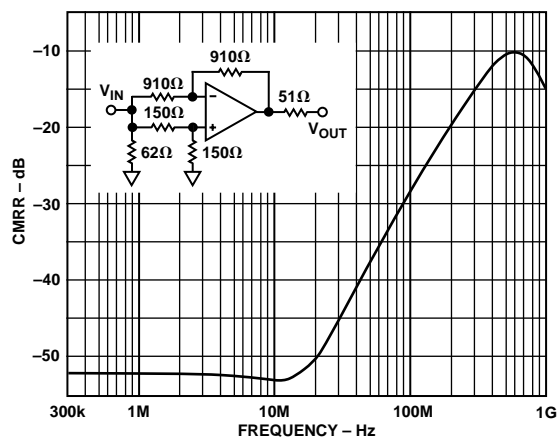

Figure 34. CMRR vs. Frequency

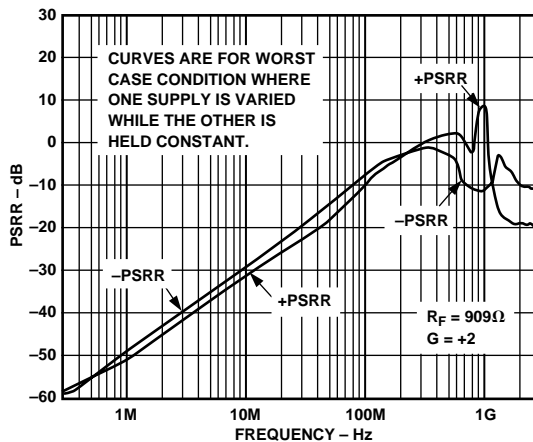

Figure 37. PSRR vs. Frequency

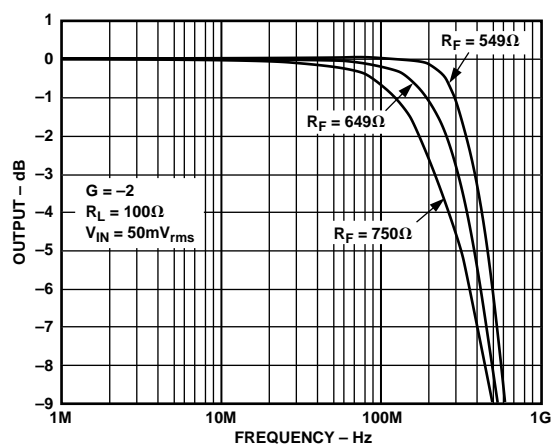

Figure 35. -3 dB Bandwidth vs. Frequency, $G = -2$

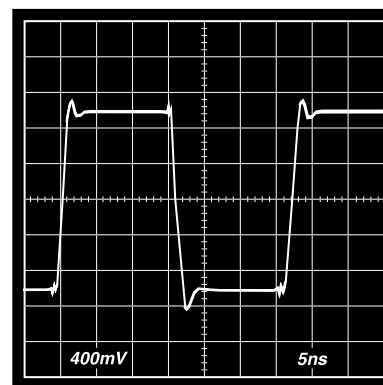

Figure 38. 2 V Step Response, $G = -1$

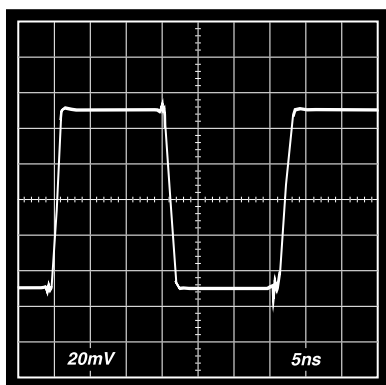

Figure 36. 100 mV Step Response, $G = -1$

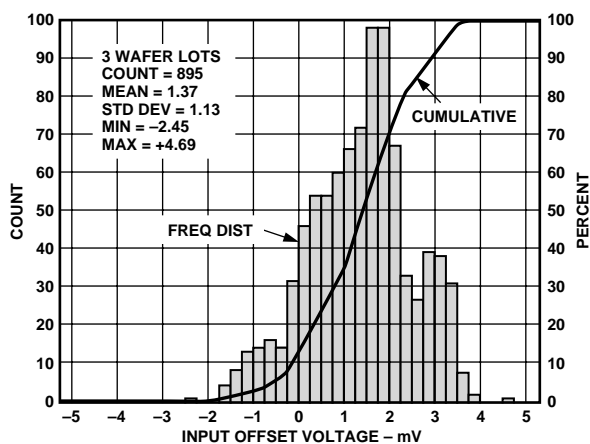

Figure 39. Input Offset Voltage Distribution

AD8001

THEORY OF OPERATION

A very simple analysis can put the operation of the AD8001, a current feedback amplifier, in familiar terms. Being a current feedback amplifier, the AD8001's open-loop behavior is expressed as transimpedance, $\Delta V_O / \Delta I_{IN}$, or T_Z . The open-loop transimpedance behaves just as the open-loop voltage gain of a voltage feedback amplifier, that is, it has a large dc value and decreases at roughly 6 dB/octave in frequency.

Since the R_{IN} is proportional to $1/g_M$, the equivalent voltage gain is just $T_Z \times g_M$, where the g_M in question is the transconductance of the input stage. This results in a low open-loop input impedance at the inverting input, a now familiar result. Using this amplifier as a follower with gain, Figure 40, basic analysis yields the following result.

$$\frac{V_O}{V_{IN}} = G \times \frac{T_Z (S)}{T_Z (S) + G \times R_{IN} + R1}$$

$$G = 1 + \frac{R1}{R2} \quad R_{IN} = 1/g_M \approx 50 \Omega$$

Recognizing that $G \times R_{IN} \ll R1$ for low gains, it can be seen to the first order that bandwidth for this amplifier is independent of gain (G). This simple analysis in conjunction with Figure 41 can, in fact, predict the behavior of the AD8001 over a wide range of conditions.

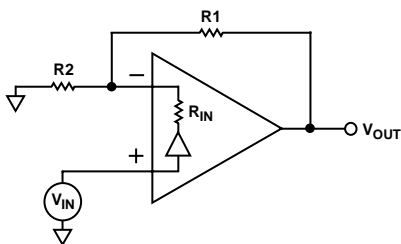

Figure 40.

Considering that additional poles contribute excess phase at high frequencies, there is a minimum feedback resistance below which peaking or oscillation may result. This fact is used to determine the optimum feedback resistance, R_F . In practice parasitic capacitance at Pin 2 will also add phase in the feedback loop, so picking an optimum value for R_F can be difficult. Figure 42 illustrates this problem. Here the fine scale (0.1 dB/div) flatness is plotted vs feedback resistance. These plots were taken using an evaluation card which is available to customers so that these results may readily be duplicated (see Evaluation Board section).

Achieving and maintaining gain flatness of better than 0.1 dB at frequencies above 10 MHz requires careful consideration of several issues.

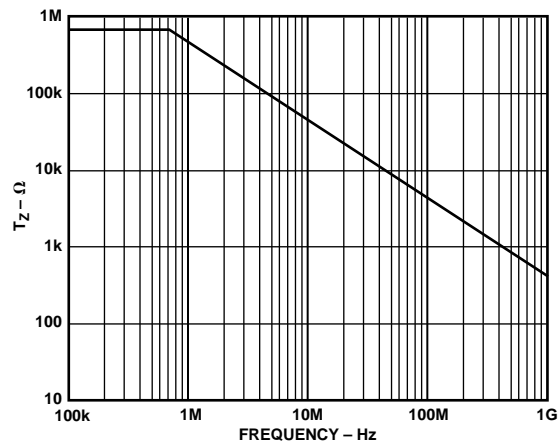

Figure 41. Transimpedance vs. Frequency

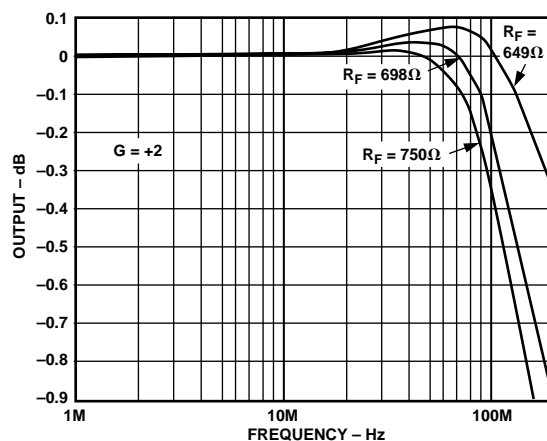

Figure 42. 0.1 dB Flatness vs. Frequency

Choice of Feedback and Gain Resistors

Because of the above-mentioned relationship between the bandwidth and feedback resistor, the fine scale gain flatness will, to some extent, vary with feedback resistance. It, therefore, is recommended that once optimum resistor values have been determined, 1% tolerance values should be used if it is desired to maintain flatness over a wide range of production lots. In addition, resistors of different construction have different associated parasitic capacitance and inductance. Surface mount resistors were used for the bulk of the characterization for this data sheet. It is not recommended that leaded components be used with the AD8001.

Printed Circuit Board Layout Considerations

As to be expected for a wideband amplifier, PC board parasitics can affect the overall closed-loop performance. Of concern are stray capacitances at the output and the inverting input nodes. If a ground plane is to be used on the same side of the board as the signal traces, a space (5 mm min) should be left around the signal lines to minimize coupling. Additionally, signal lines connecting the feedback and gain resistors should be short enough so that their associated inductance does not cause high frequency gain errors. Line lengths on the order of less than 5 mm are recommended. If long runs of coaxial cable are being driven, dispersion and loss must be considered.

Power Supply Bypassing

Adequate power supply bypassing can be critical when optimizing the performance of a high frequency circuit. Inductance in the power supply leads can form resonant circuits that produce peaking in the amplifier's response. In addition, if large current transients must be delivered to the load, then bypass capacitors (typically greater than 1 μF) will be required to provide the best settling time and lowest distortion. A parallel combination of 4.7 μF and 0.1 μF is recommended. Some brands of electrolytic capacitors will require a small series damping resistor $\approx 4.7 \Omega$ for optimum results.

DC Errors and Noise

There are three major noise and offset terms to consider in a current feedback amplifier. For offset errors refer to the equation below. For noise error the terms are root-sum-squared to give a net output error. In the circuit below (Figure 43) they are input offset (V_{IO}) which appears at the output multiplied by the noise gain of the circuit ($1 + R_F/R_I$), noninverting input current ($I_{BN} \times R_N$) also multiplied by the noise gain, and the inverting input current, which when divided between R_F and R_I and subsequently multiplied by the noise gain always appears at the output as $I_{BI} \times R_F$. The input voltage noise of the AD8001 is a low 2 $\text{nV}/\sqrt{\text{Hz}}$. At low gains though the inverting input current noise times R_F is the dominant noise source. Careful layout and device matching contribute to better offset and drift specifications for the AD8001 compared to many other current feedback amplifiers. The typical performance curves in conjunction with the equations below can be used to predict the performance of the AD8001 in any application.

$$V_{OUT} = V_{IO} \times \left(1 + \frac{R_F}{R_I}\right) \pm I_{BN} \times R_N \times \left(1 + \frac{R_F}{R_I}\right) \pm I_{BI} \times R_F$$

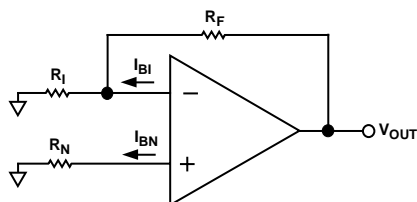

Figure 43. Output Offset Voltage

Driving Capacitive Loads

The AD8001 was designed primarily to drive nonreactive loads. If driving loads with a capacitive component is desired, best frequency response is obtained by the addition of a small series resistance as shown in Figure 44. The accompanying graph shows the optimum value for R_{SERIES} vs. capacitive load. It is worth noting that the frequency response of the circuit when driving large capacitive loads will be dominated by the passive roll-off of R_{SERIES} and C_L .

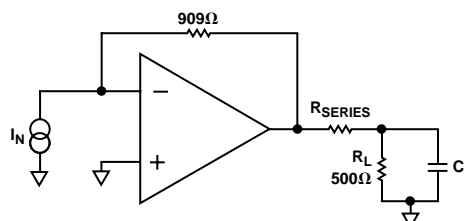

Figure 44. Driving Capacitive Loads

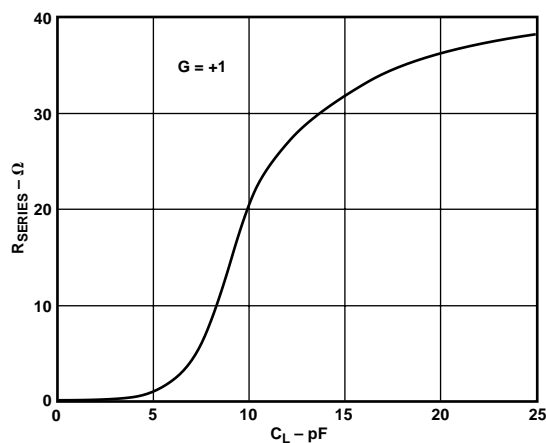

Figure 45. Recommended R_{SERIES} vs. Capacitive Load

AD8001

Communications

Distortion is a key specification in communications applications. Intermodulation distortion (IMD) is a measure of the ability of an amplifier to pass complex signals without the generation of spurious harmonics. The third order products are usually the most problematic since several of them fall near the fundamentals and do not lend themselves to filtering. Theory predicts that the third order harmonic distortion components increase in power at three times the rate of the fundamental tones. The specification of third order intercept as the virtual point where fundamental and harmonic power are equal is one standard measure of distortion performance. Op amps used in closed-loop applications do not always obey this simple theory. At a gain of two, the AD8001 has performance summarized in Figure 46. Here the worst third order products are plotted vs. input power. The third order intercept of the AD8001 is +33 dBm at 10 MHz.

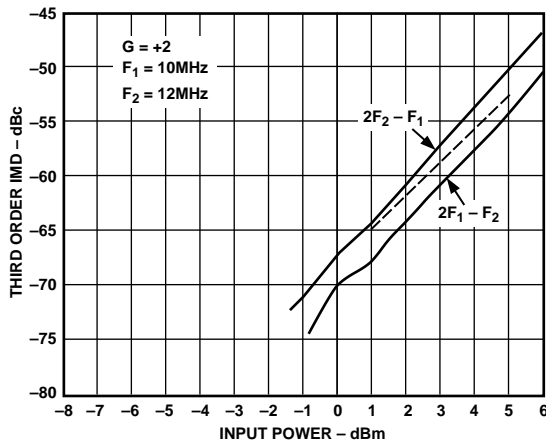

Figure 46. Third Order IMD; $F_1 = 10$ MHz, $F_2 = 12$ MHz

Operation as a Video Line Driver

The AD8001 has been designed to offer outstanding performance as a video line driver. The important specifications of differential gain (0.01%) and differential phase (0.025°) meet the most exacting HDTV demands for driving one video load. The AD8001 also drives up to two back terminated loads as shown in Figure 47, with equally impressive performance (0.01%, 0.07°). Another important consideration is isolation between loads in a multiple load application. The AD8001 has more than 40 dB of isolation at 5 MHz when driving two 75 Ω back terminated loads.

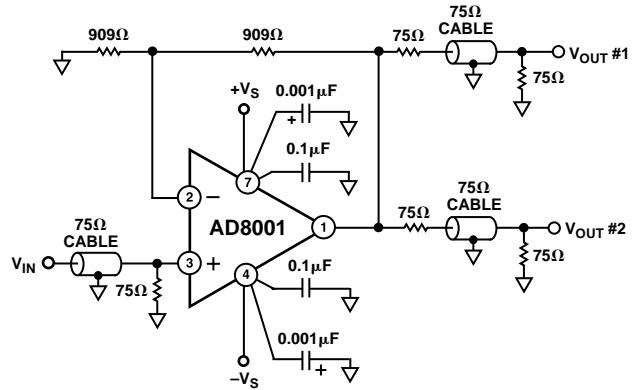

Figure 47. Video Line Driver

Driving A-to-D Converters

The AD8001 is well suited for driving high speed analog-to-digital converters such as the AD9058. The AD9058 is a dual 8-bit 50 MSPS ADC. In the circuit below the AD8001 is shown driving the inputs of the AD9058, which are configured for 0 V to +2 V ranges. Bipolar input signals are buffered, amplified ($-2\times$), and offset (by +1.0 V) into the proper input range of the ADC. Using the AD9058's internal +2 V reference connected

to both ADCs as shown in Figure 48 reduces the number of external components required to create a complete data acquisition system. The $20\ \Omega$ resistors in series with ADC inputs are used to help the AD8001s drive the 10 pF ADC input capacitance. The AD8001 only adds 100 mW to the power consumption while not limiting the performance of the circuit.

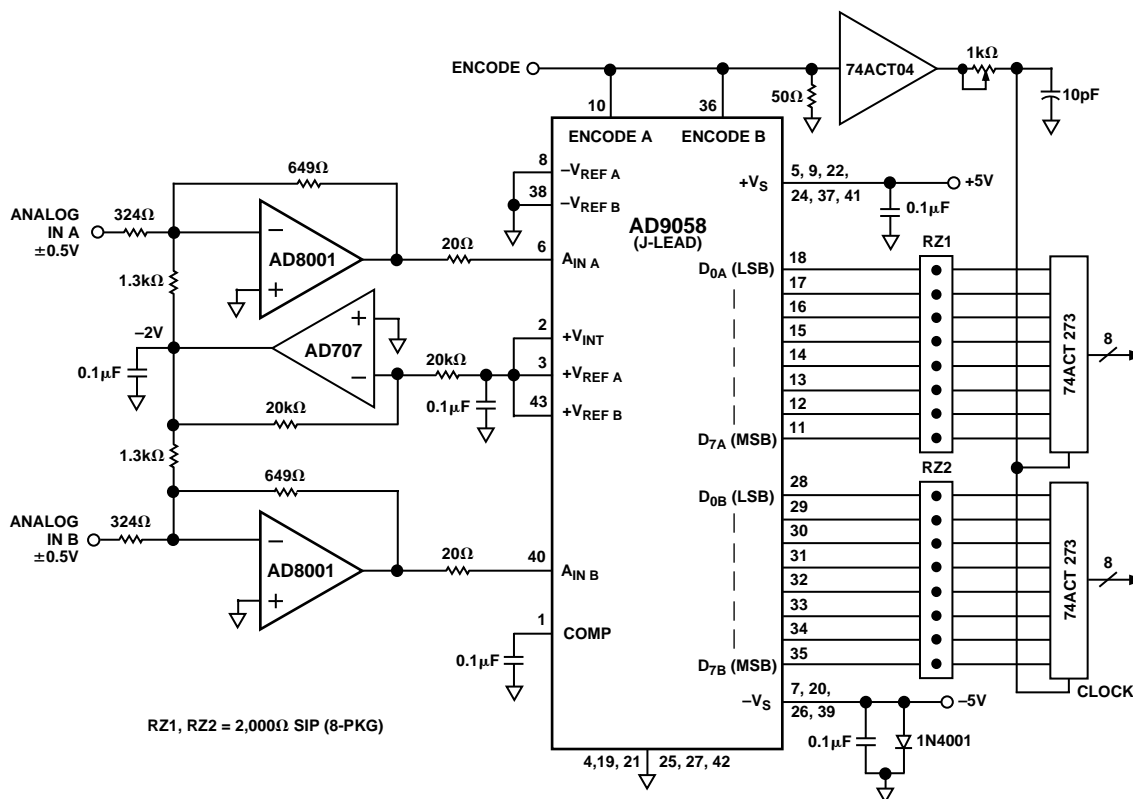

Figure 48. AD8001 Driving a Dual A-to-D Converter

AD8001

Layout Considerations

The specified high speed performance of the AD8001 requires careful attention to board layout and component selection.

Proper R_F design techniques and low parasitic component selection are mandatory.

The PCB should have a ground plane covering all unused portions of the component side of the board to provide a low impedance ground path. The ground plane should be removed from the area near the input pins to reduce stray capacitance.

Chip capacitors should be used for supply bypassing (see Figure 49). One end should be connected to the ground plane and the other within 1/8-inch of each power pin. An additional large

(4.7 μF –10 μF) tantalum electrolytic capacitor should be connected in parallel, but not necessarily so close, to supply current for fast, large-signal changes at the output.

The feedback resistor should be located close to the inverting input pin in order to keep the stray capacitance at this node to a minimum. Capacitance variations of less than 1 pF at the inverting input will significantly affect high speed performance.

Stripline design techniques should be used for long signal traces (greater than about 1 in.). These should be designed with a characteristic impedance of 50 Ω or 75 Ω and be properly terminated at each end.

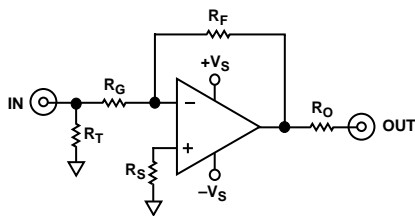

Inverting Configuration

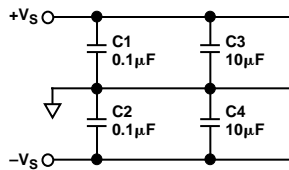

Supply Bypassing

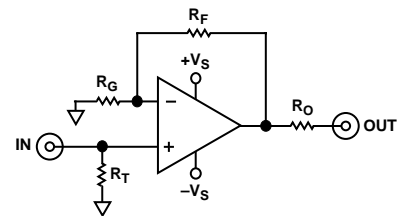

Noninverting Configuration

Figure 49. Inverting and Noninverting Configurations for Evaluation Boards

Table I. Recommended Component Values

| Component | AD8001AN (DIP) Gain | | | | | AD8001AR (SOIC) Gain | | | | | AD8001ART (SOT-23-5) Gain | | | | |
|------------------------------|------------------------|------|------|------|------|-------------------------|------|------|------|------|------------------------------|------|------|------|------|
| | -1 | +1 | +2 | +10 | +100 | -1 | +1 | +2 | +10 | +100 | -1 | +1 | +2 | +10 | +100 |
| R_F (Ω) | 649 | 1050 | 750 | 470 | 1000 | 604 | 953 | 681 | 470 | 1000 | 845 | 1000 | 768 | 470 | 1000 |
| R_G (Ω) | 649 | | 750 | 51 | 10 | 604 | | 681 | 51 | 10 | 845 | | 768 | 51 | 10 |
| R_O (Nominal) (Ω) | 49.9 | 49.9 | 49.9 | 49.9 | 49.9 | 49.9 | 49.9 | 49.9 | 49.9 | 49.9 | 49.9 | 49.9 | 49.9 | 49.9 | 49.9 |
| R_S (Ω) | 0 | | | | | 0 | | | | | 0 | | | | |
| R_T (Nominal) (Ω) | 54.9 | 49.9 | 49.9 | 49.9 | 49.9 | 54.9 | 49.9 | 49.9 | 49.9 | 49.9 | 54.9 | 49.9 | 49.9 | 49.9 | 49.9 |
| Small Signal BW (MHz) | 340 | 880 | 460 | 260 | 20 | 370 | 710 | 440 | 260 | 20 | 240 | 795 | 380 | 260 | 20 |
| 0.1 dB Flatness (MHz) | 105 | 70 | 105 | | | 130 | 100 | 120 | | | 110 | 300 | 145 | | |

Evaluation Board

An evaluation board for the AD8001 is available that has been carefully laid-out and tested to demonstrate that the specified high speed performance of the device can be realized. For

ordering information, please refer to the Ordering Guide. The layout of the evaluation board can be used as shown or serve as a guide for a board layout.

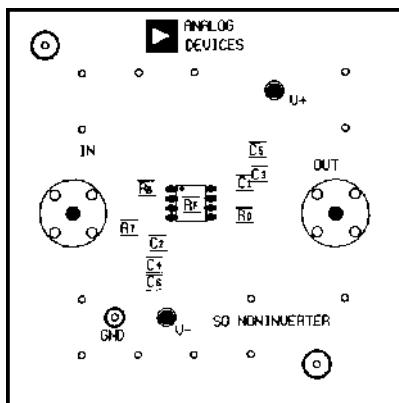

Figure 50. Evaluation Board Silkscreen (Top)

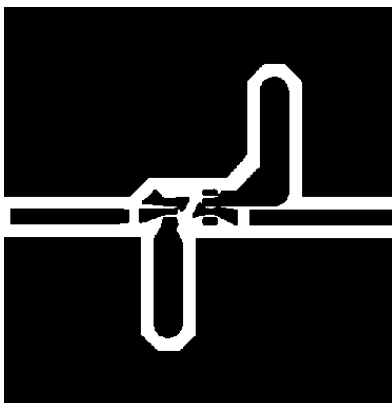

Figure 51. Evaluation Board Layout (Solder Side)

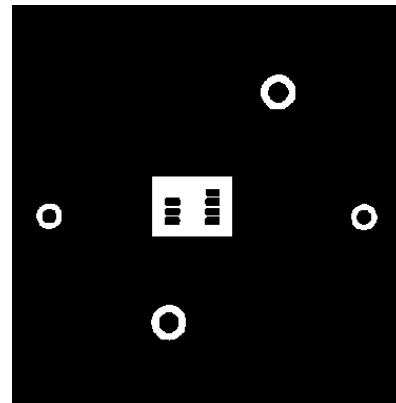
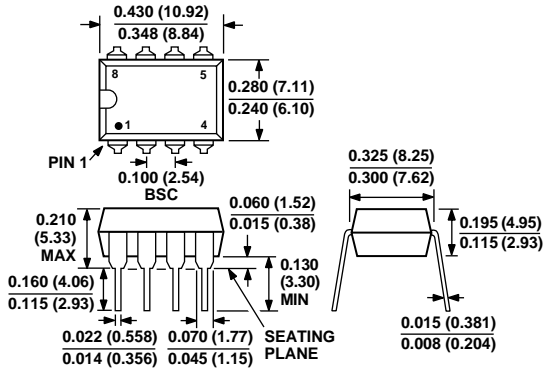

Figure 52. Evaluation Board Layout (Component Side)

OUTLINE DIMENSIONS

Dimensions shown in inches and (mm).

8-Lead Plastic DIP (N-8)



8-Lead Cerdip (Q-8)

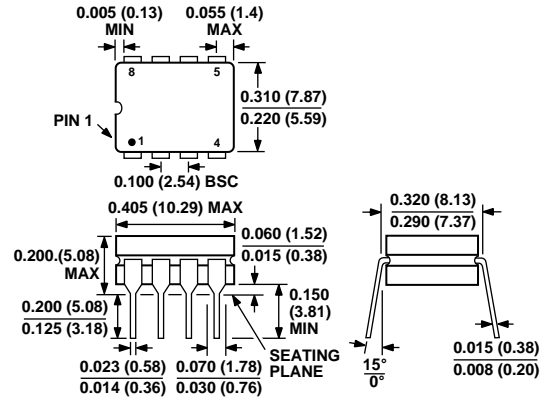

8-Lead Plastic SOIC (SO-8)

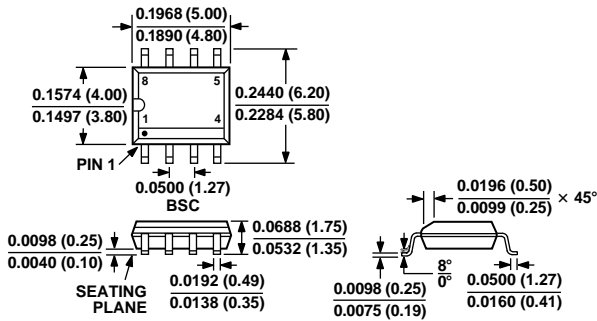

5-Lead Plastic Surface Mount (SOT-23) (RT-5)

