

# S-100 TS-4 Series Tiny Toggle Switches

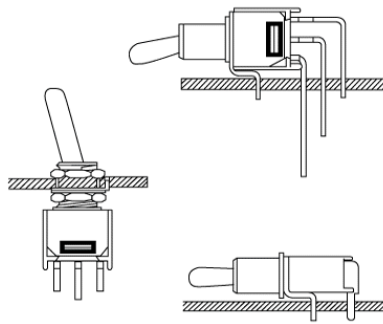

**S-100 1,3PIN**  
3A 120V  
1.5A 250V



## SPECIFICATION:

Rating : 3A 120V AC, 28V DC  
 Contact resistance : 1.5A 250V AC or 0.4VA 20V AC or DC  
 : 20mΩ Max. initial @2-4V DC,  
 100mA for both coin Silver and Gold plated contacts.  
 Insulation resistance : 1,000MΩ Min.  
 Withstand voltage : 1,000 RMS @sea level.  
 Operating temperature : -30°C ~ +85°C  
 Electrical life : 6,000 Cycles.

## MATERIALS:

Case : Dially phthalate.(DAP)(UL-94V-0)  
 Actuator : Zinc alloy.  
 Bushing : Zinc alloy.  
 Housing : Stainless steel.  
 Terminal / Contact : Brass, Silver or Gold plated.



**TS COLOR CAP**

## SPDT



**TS-41BSTQ,**  
S-100

MODEL NO.	SWITCHING POSITION		
TS - 40	ON	NONE	OFF
TS - 41	ON	NONE	ON
TS - 42	ON	NONE	(ON)
TS - 43	ON	OFF	ON
Term. Com.	2 - 3	OPEN	2 - 1

Schematic

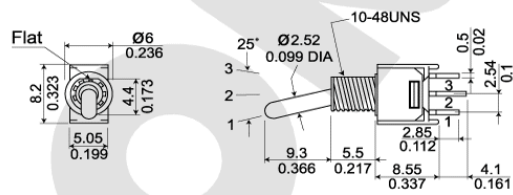

## DPDT



**TS-51BSTQ**

MODEL NO.	SWITCHING POSITION		
TS - 50	ON	NONE	OFF
TS - 51	ON	NONE	ON
TS - 52	ON	NONE	(ON)
TS - 53	ON	OFF	ON
Term. Com.	2 - 3	OPEN	2 - 1
	5 - 6		5 - 4

Schematic

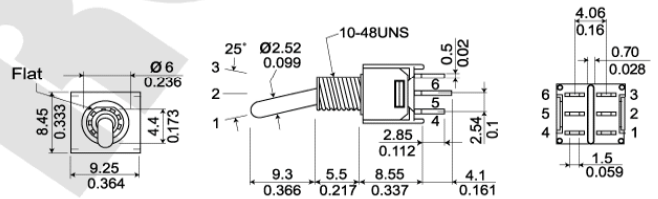

## SPDT



**TS-41P**

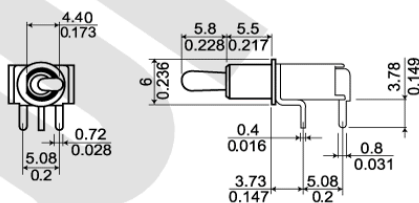

## P.C.B. LAYOUT

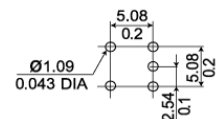

## DPDT

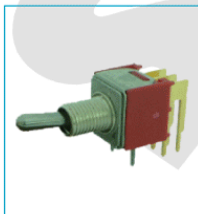

**TS-51P**

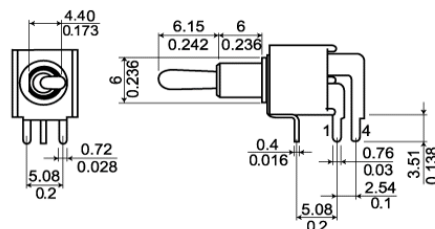

## P.C.B. LAYOUT

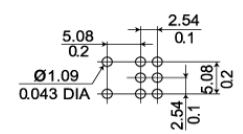

# TS-4 Series Tiny Toggle, Tiny Rocker Switches

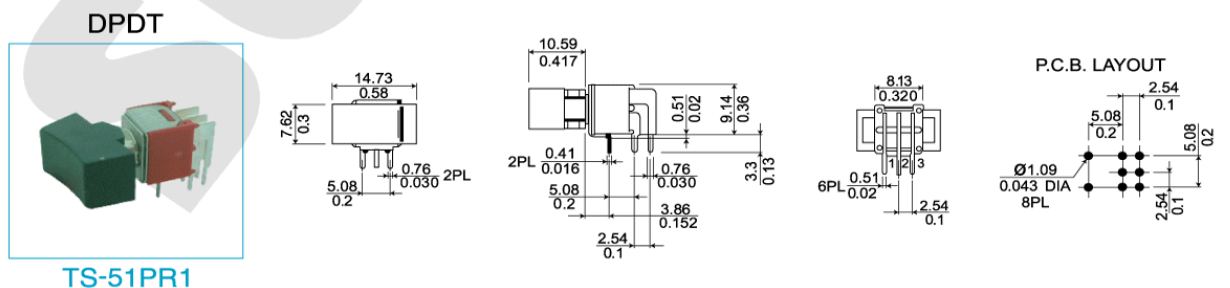
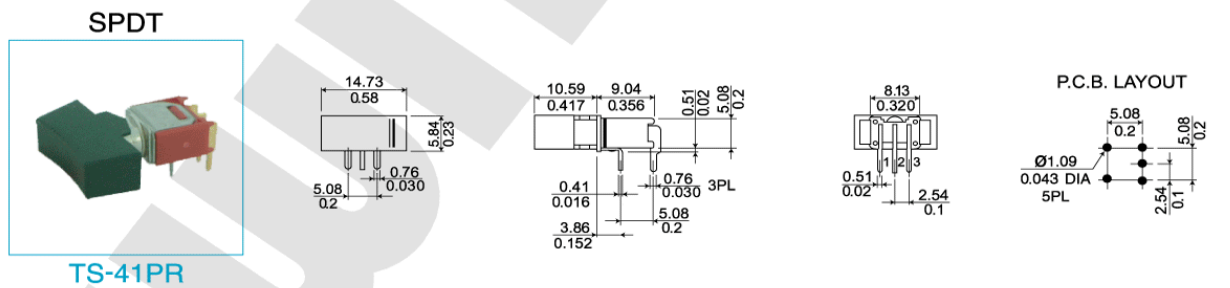
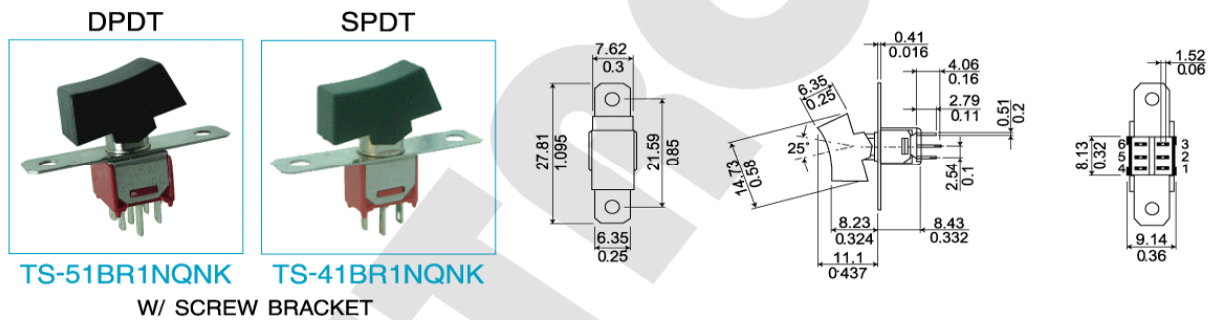
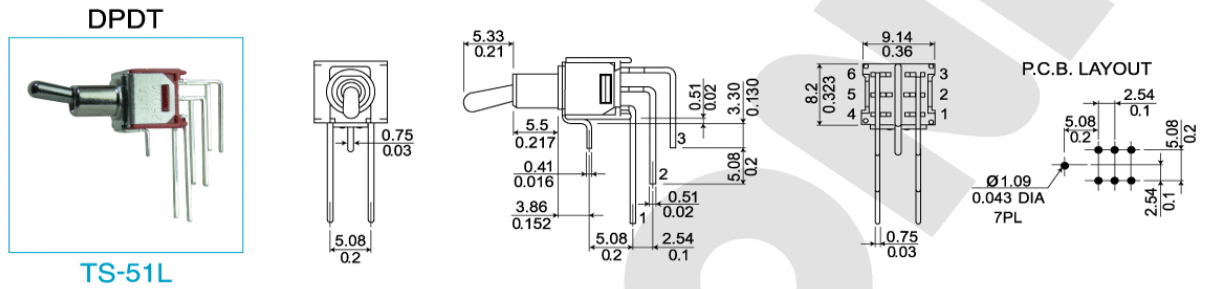
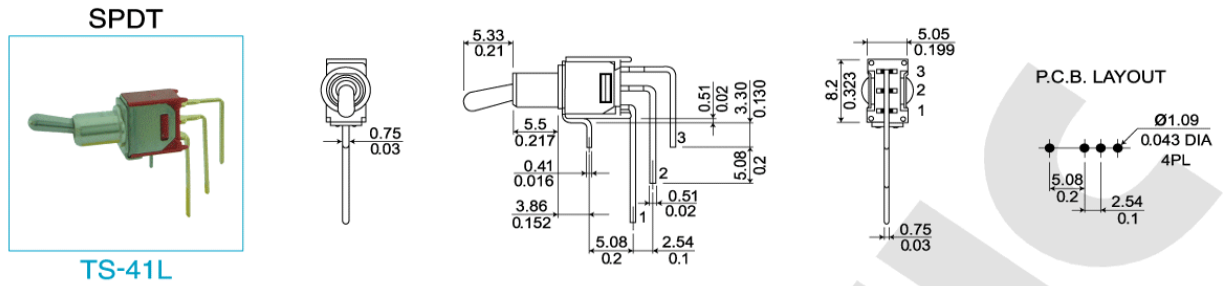

# TS-4 Series Tiny Toggle, Tiny Rocker Switches



SPDT

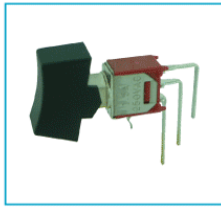

TS-41LRNQN

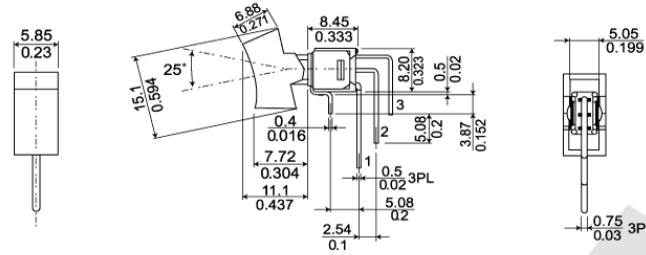

DPDT

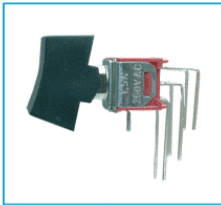

TS-51LR1NQN

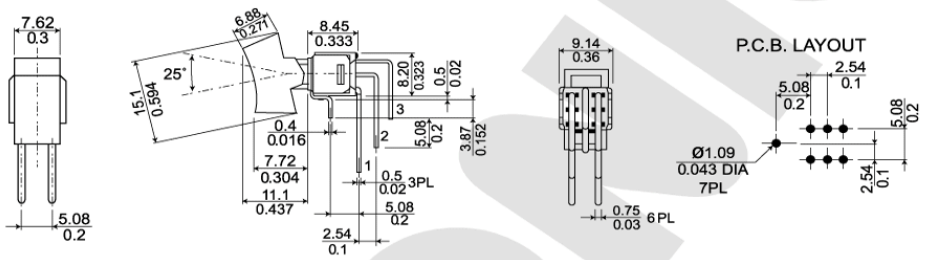

SPDT

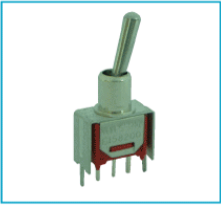

TS-41VSS

SPDT

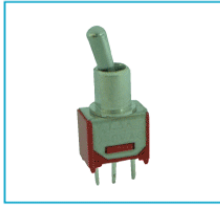

TS-41CTNQ  
(W/O SUPPORT)

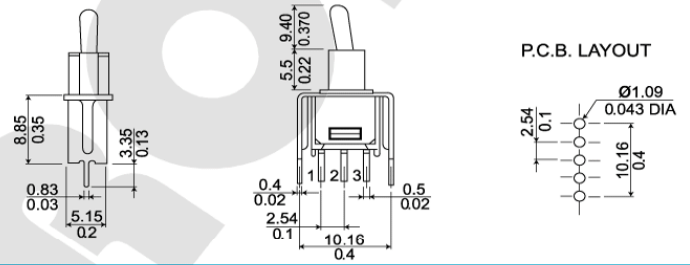

SPDT



TS-41VSR

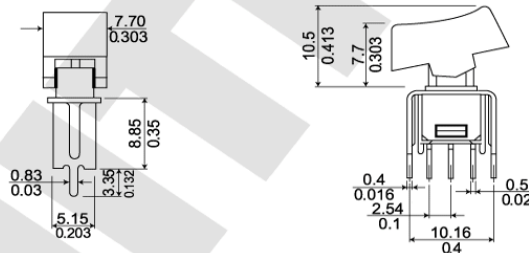

## TERMINAL OPTIONS

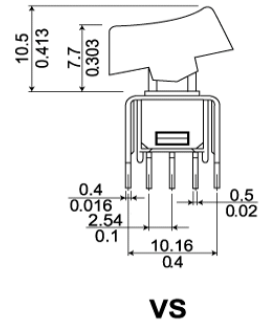
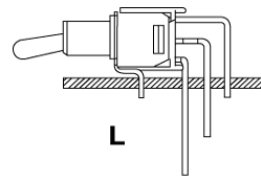
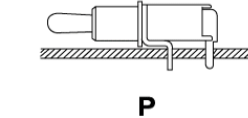
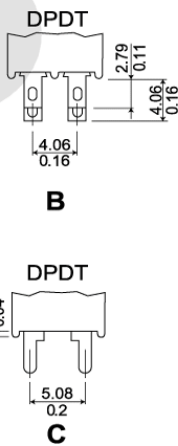
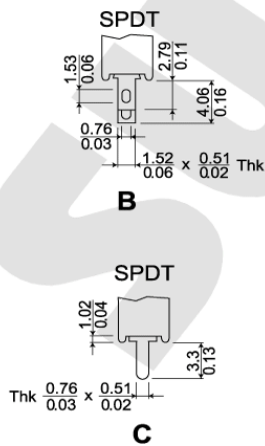

# TS-4 Series Tiny Toggle Paddle Switches



## ACTUATOR OPTIONS

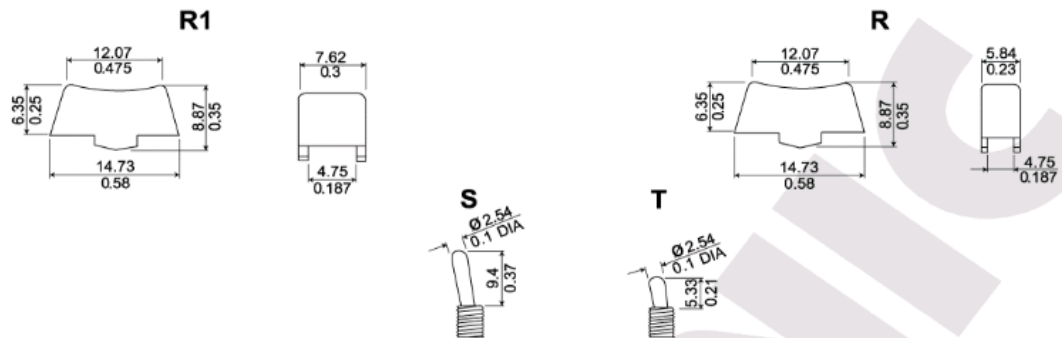

## CONTACT MATERIAL

### Q : Silver

End contact : Coin Silver, Silver plated.  
 Center contact / All terminal : Brass, Silver plated.  
 Rating : 3A @ 120V AC or 28V DC; 1.5A @ 250V AC.

### R : Gold

Contact / Terminal : Gold over Nickel plated, Copper alloy.  
 Rating : 0.4 VA Max. 20V DC.

## HOW TO ORDER

MODEL NO.	+	TERMINAL	+	ACTUATOR (HANDLE)	+	BUSHING	+	CONTACT & TERMINAL MATERIAL	+	EPOXY SEAL	+	BRACKET	+	KINK PIN	+	NUTS & WASHER
		B L C VS P		S R T R1		T : THREAD N : NON-THREAD		Q : SILVER R : GOLD		Y : YES N : NO		<input type="checkbox"/> : NON BRACKET K : SCREW BRACKET		<input type="checkbox"/> : NON S : KINK PIN		<input type="checkbox"/> : SEPARATE PACKING 1 : FIXED ON S/W