

Ambient Light Sensor ICs

Analog Current Output Type Ambient Light Sensor IC

BH1680FVC

No.12046EBT14

●Descriptions

BH1680FVC is an analog current output ambient light sensor. This IC can detect the illuminance from 0lx to 50000lx. It is the most suitable to obtain the ambient light data for adjusting LCD and Keypad backlight of Mobile phone for power saving and better visibility. It is suitable also for the use of optical window that the visible light transmission is low because of the high sensitivity type.

●Features

- 1) Compact surface mount package 1.6 x 1.6 mm
- 2) Output current in proportion to brightness
- 3) Suitable for optical window that the visible light transmission is low (High sensitivity type)
- 4) The influence of infrared is very small by an infrared cut filter
- 5) Supply voltage operates from 2.4V to 5.5V
- 6) Built-in shutdown function
- 7) 3 steps controllable output current gain
- 8) 1.8V logic input interface
- 9) Low sensitivity variation (+/-15%)

●Applications

Mobile phone, LCD TV, PDP TV, Laptop PC, Portable game console, Digital camera, Digital video camera, LCD display

●Absolute Maximum Ratings

Parameter	Symbol	Limits	Units
Supply Voltage	Vmax	7	V
Operating Temperature	Topr	-40~85	°C
Storage Temperature	Tstg	-40~100	°C
Iout Current	Ioutmax	7.5	mA
Power Dissipation	Pd	165*	mW

* 70mm x 70mm x 1.6mm glass epoxy board. Derating at 2.2 mW/°C for operating above Ta=25°C.

●Operating Conditions

Parameter	Symbol	Min.	Typ.	Max.	Units
Vcc Voltage	Vcc	2.4	3.0	5.5	V

●Electrical Characteristics (Vcc = 3.0V, Ta = 25°C, unless otherwise noted)

Parameter	Symbol	Min.	Typ.	Max.	Units	Conditions
Supply Current1 (Operate)	Icc1	51.9	75	105	μA	Ev=10 lx (H-Gain Mode)*
Supply Current2 (0 lx)	Icc2	4.5	9	13.5	μA	Ev=0 lx (H-Gain Mode)
Supply Current3 (Shutdown)	Icc3sd	-	0.2	0.4	μA	V _{GC1} =V _{GC2} =0 No Input Light
IOUT Output Current1(Dark Current)	Iout1	-	-	0.2	μA	Ev=0 lx
IOUT Output Current2	Iout2	51.9	61	70.1	μA	Ev=10 lx (H-Gain Mode)*
Peak Wave Length	λp	-	530	-	nm	
Saturated Output Voltage	V _{OMAX}	2.6	2.9	3.0	V	Ev=10 lx, RL=220kΩ (H-Gain Mode)*
GC1,GC2 Input 'L' Voltage	V _{IL}	0	-	0.4	V	
GC1,GC2 Input 'H' Voltage1	V _{IH1}	1.4	-	Vcc	V	2.4V ≤ VCC ≤ 3.6V
GC1,GC2 Input 'H' Voltage2	V _{IH2}	2.0	-	Vcc	V	3.6V < VCC ≤ 5.5V
Wake-up Time	twu	-	13	52	μs	Shutdown → H-Gain Mode Ev=100lx*
Gain Ratio H-Gain Mode/M-Gain Mode	rHM	8	10	12	times	Ev=10lx*
Gain Ratio M-Gain Mode/L-Gain Mode	rML	8	10	12	times	Ev=10lx*

* White LED is used as optical source

●Reference Data

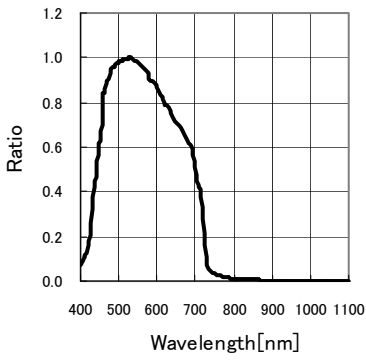

Fig.1 Spectral Response

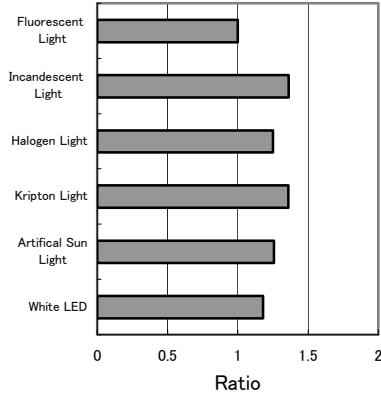

Fig.2 Light Source Dependency (Fluorescent Light is set to '1')

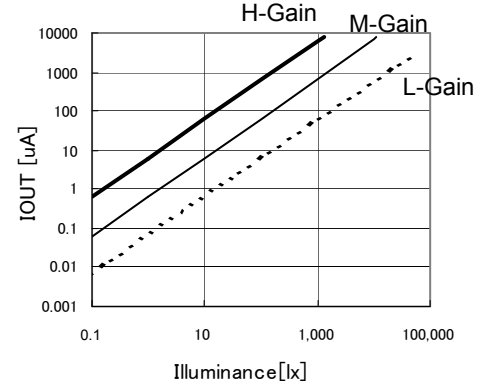

Fig.3 Illuminance - IOUT Characteristics

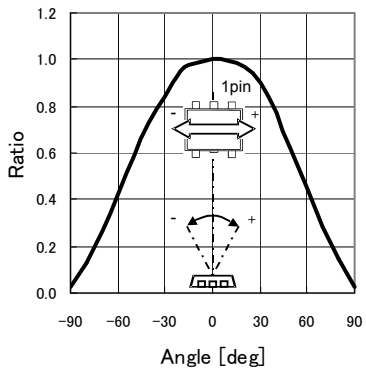

Fig.4 Directional Characteristics 1

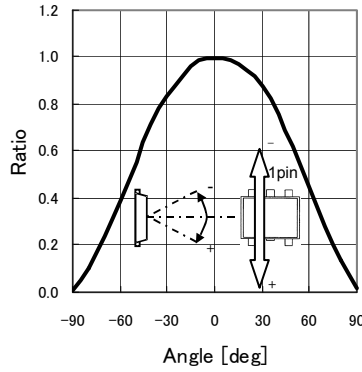

Fig.5 Directional Characteristics 2

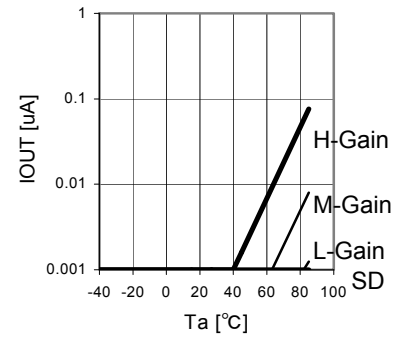

Fig.6 Ta - IOUT (0 lx)

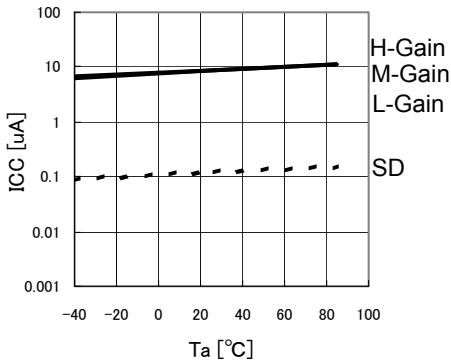

Fig.7 Ta - ICC (0 lx)

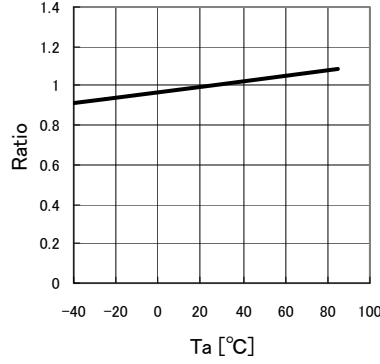

Fig.8 IOUT Temperature dependency (10 lx)

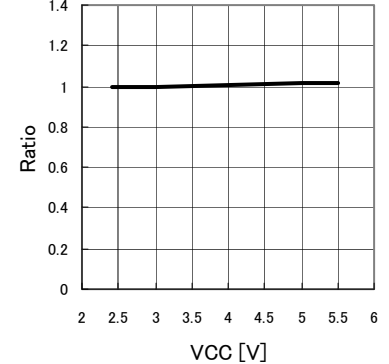

Fig.9 IOUT VCC dependency

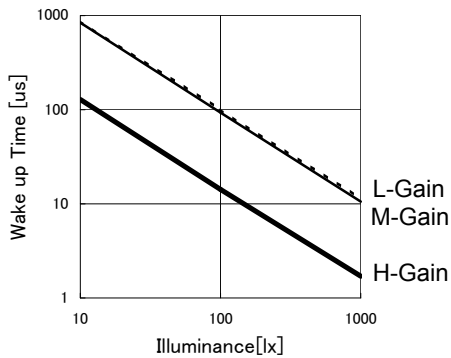
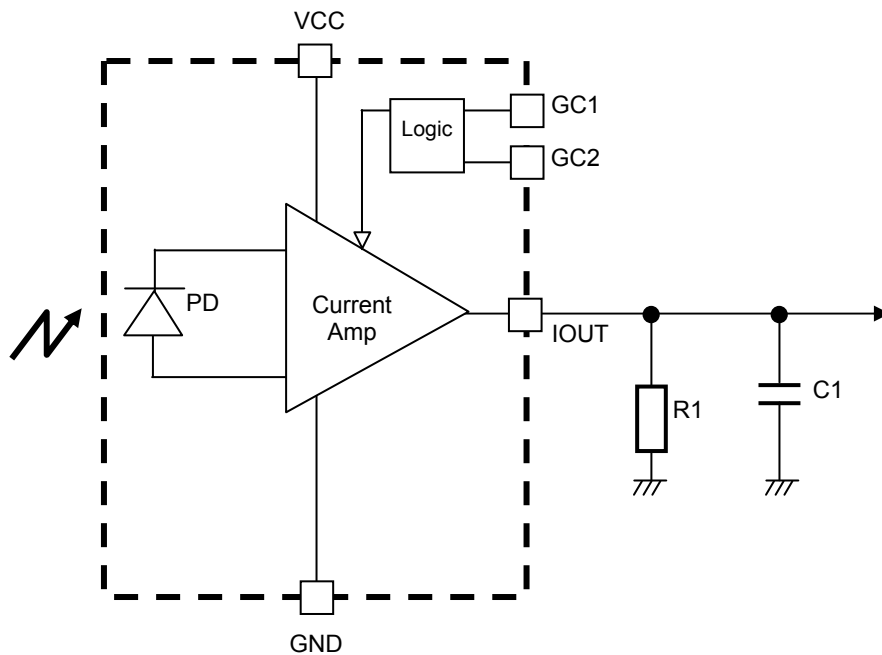

Fig.10 Illuminance - Wake up Time

●Block Diagram



●Block Diagram Descriptions

- PD
Photo diode detects the visible light, and cuts the infrared.
- Current AMP
To amplify Photo diode current (H-Gain / M-Gain / L-Gain)
Gain controllable in 3 steps by input voltage from GC1 and GC2.
- Logic
Logic block for mode setting by input voltage from GC1 and GC2

●Mode Setting

GC2	GC1	Mode
0	0	Shutdown
0	1	H-Gain Mode
1	0	M-Gain Mode
1	1	L-Gain Mode

●External parts Setting

1) Gain setting of BH1680FVC

Please select the best gain controlled by 3 and 4pin based on the required illuminance range.
The reference is as follows.

Illuminance detection range [lx]	Gain Mode
~100	H-Gain Mode
~1,000	M-Gain Mode
~50,000	L-Gain Mode

This device will be mounted under the optical window in actual designing. Therefore, there is a possibility that the illuminance to ALS(Ambient Light Sensor) will be less than the illuminance on the final product surface. Please consider the attenuation of light through the optical window. Please set output resistance value(R1) within the range of 1 kΩ~1MΩ which needs to be smaller than the input impedance of the next circuit.

2) Approximate formula of IOUT output voltage in each Gain Mode

(1) H-Gain mode

The output voltage is calculated as below.

$$V_{iout} = 6.1 \times 10^{-6} \times E_v \times R_1$$

V_{iout} is IOUT output voltage [V]. E_v is an illuminance of the ALS surface [lx].

R_1 is IOUT output resistor[Ω].

(For example) In case you want to convert the illuminance value up to 50 lx by ADC.

If the maximum voltage of ADC input is 2V, output resistor value will be as below.

$$\begin{aligned} R_1 &= V_{iout} / (6.1 \times 10^{-6} \times E_v) \\ &= 2 / (6.1 \times 10^{-6} \times 50) = 6557[\Omega] \\ &\Rightarrow 6.8[\text{k}\Omega] \end{aligned}$$

(2) M-Gain mode

$$V_{iout} = 0.61 \times 10^{-6} \times E_v \times R_1$$

(3) L-Gain mode

$$V_{iout} = 0.061 \times 10^{-6} \times E_v \times R_1$$

3) C1

(1) To reject the flicker light.

In case IOUT output is R1 only and an ALS receives the artificial lights such as fluorescent lamps and incandescent lamps synchronized with 50/60 Hz of AC power supplies, the output current has a ripple. If you want to reject this ripple, please add C1 to R1 in parallel. Please set it to $C1 \times R1 =$ about 0.1 as a time constant.

(For example) If the $R1 = 6.8[\text{k}\Omega]$, C1 value will be as below.

$$\begin{aligned} C1 &= 0.1 / R1 \\ &= 0.1 / (6.8 \times 10^3) = 14.7 \times 10^{-6}[\text{F}] \\ &\Rightarrow 15[\mu\text{F}] \end{aligned}$$

(2) To control backlight smoothly by using illuminance value.

C1 is effective to control backlight smoothly for a rapid changing of the illuminance. In this case, please set it to $C1 \times R1 =$ about 1 ~ 10 as a time constant. It is not necessary if you average illuminance value with software to change backlight smoothly.

Please note that the rise time becomes slow at power-on and recovery from shutdown mode to operation mode.

●Terminal Descriptions

PIN No.	Terminal Name	Equivalent Circuit	Function
1	VCC		Power Supply Terminal
2	GND		GND Terminal
3	GC1		Mode Setting Terminal 1
4	GC2		Mode Setting Terminal 2
5	IOUT		This terminal outputs current depending on illuminance level. Use this pin by putting resistor between GND.

●Package Outlines

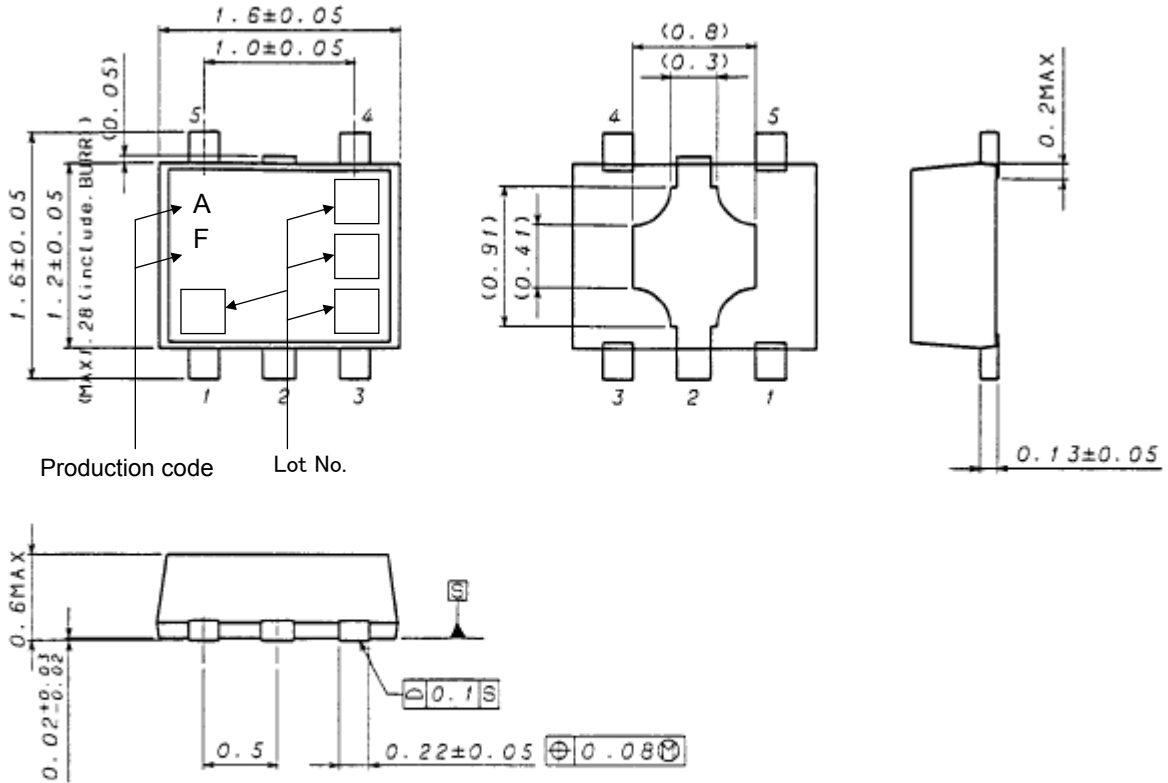

WSOF5 (Unit : mm)

●Optical design for the device

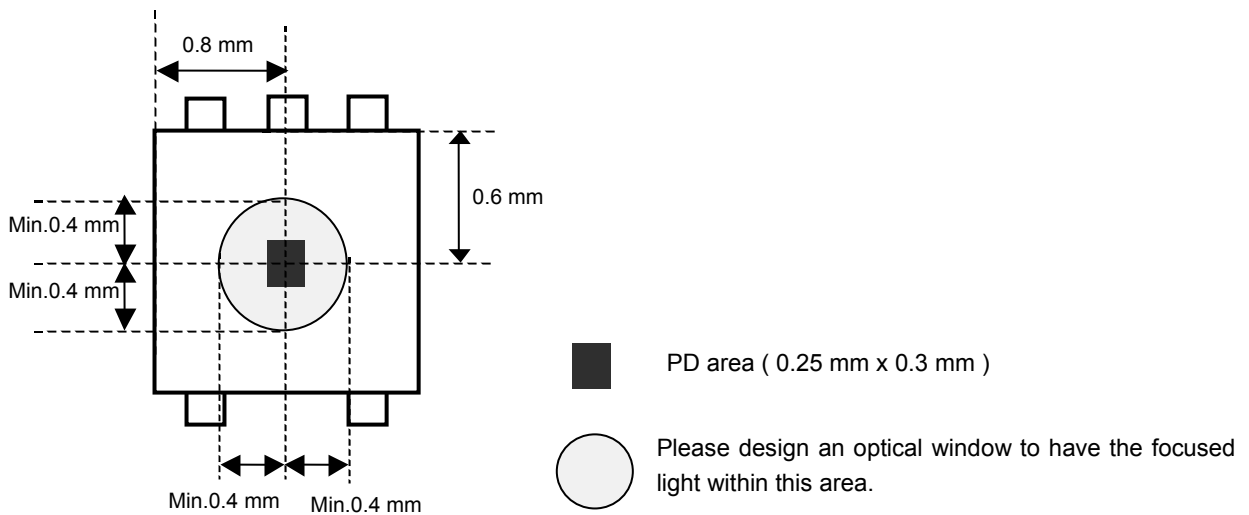

●Cautions on use

1) Absolute Maximum Ratings

An excess in the absolute maximum ratings, such as supply voltage (V_{max}), temperature range of operating conditions (T_{opr}), etc., can break down devices, thus making impossible to identify breaking mode such as a short circuit or an open circuit. If any special mode exceeding the absolute maximum ratings is assumed, consideration should be given to take physical safety measures including the use of fuses, etc.

2) GND voltage

Make setting of the potential of the GND terminal so that it will be maintained at the minimum in any operating state. Furthermore, check to be sure no terminals are at a potential lower than the GND voltage including an actual electric transient.

3) Short circuit between terminals and erroneous mounting

In order to mount ICs on a set PCB, pay thorough attention to the direction and offset of the ICs. Erroneous mounting can break down the ICs. Furthermore, if a short circuit occurs due to foreign matters entering between terminals or between the terminal and the power supply or the GND terminal, the ICs can break down.

4) Operation in strong electromagnetic field

Be noted that using ICs in the strong electromagnetic field can malfunction them.

5) Inspection with set PCB

On the inspection with the set PCB, if a capacitor is connected to a low-impedance IC terminal, the IC can suffer stress. Therefore, be sure to discharge from the set PCB by each process. Furthermore, in order to mount or dismount the set PCB to/from the jig for the inspection process, be sure to turn OFF the power supply and then mount the set PCB to the jig. After the completion of the inspection, be sure to turn OFF the power supply and then dismount it from the jig. In addition, for protection against static electricity, establish a ground for the assembly process and pay thorough attention to the transportation and the storage of the set PCB.

6) Input terminals

In terms of the construction of IC, parasitic elements are inevitably formed in relation to potential. The operation of the parasitic element can cause interference with circuit operation, thus resulting in a malfunction and then breakdown of the input terminal. Therefore, pay thorough attention not to handle the input terminals; such as to apply to the input terminals a voltage lower than the GND respectively, so that any parasitic element will operate. Furthermore, do not apply a voltage to the input terminals when no power supply voltage is applied to the IC. In addition, even if the power supply voltage is applied, apply to the input terminals a voltage lower than the power supply voltage or within the guaranteed value of electrical characteristics.

7) Thermal design

Perform thermal design in which there are adequate margins by taking into account the permissible dissipation (pd) in actual states of use.

8) Treatment of package

Dusts or scratch on the photo detector may affect the optical characteristics. Please handle it with care.

9) Rush current

When power is first supplied to this IC, rush current may flow instantaneously. Because it is possible that the charge current to the parasitic capacitance of internal photo diode or the internal logic may be unstable. Therefore, give special consideration to power coupling capacitance, power wiring, width of GND wiring, and routing of connections.

10) The exposed central pad on the back side of the package

There is an exposed central pad on the back side of the package. Please mount by footprint dimensions described in the Jisso Information for WSOF5. This pad is GND pin, therefore there is a possibility that LSI malfunctions and heavy-current is generated.

●Ordering part number

B	H
---	---

Part No.

1	6	8	0
---	---	---	---

Part No.

F	V	C
---	---	---

Package
FVC: WSOF5

T	R
---	---

Packaging and forming specification
TR: Embossed tape and reel

WSOF5

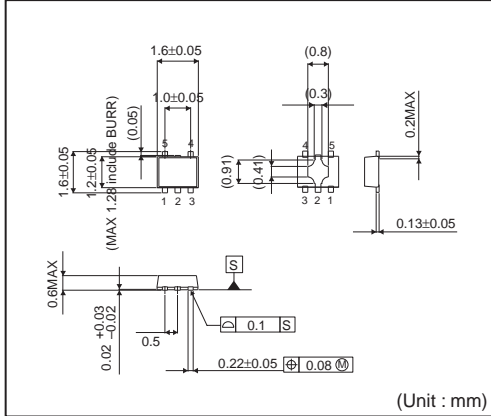

<Tape and Reel information>

Tape	Embossed carrier tape
Quantity	3000pcs
Direction of feed	TR (The direction is the 1pin of product is at the upper right when you hold reel on the left hand and you pull out the tape on the right hand)

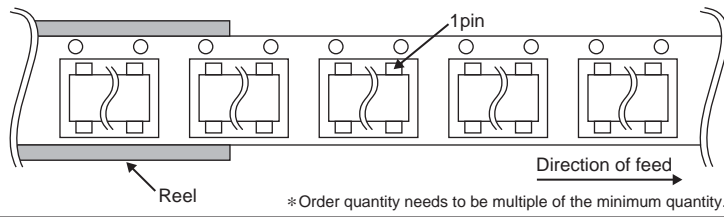

Notice

Precaution on using ROHM Products

- Our Products are designed and manufactured for application in ordinary electronic equipments (such as AV equipment, OA equipment, telecommunication equipment, home electronic appliances, amusement equipment, etc.). If you intend to use our Products in devices requiring extremely high reliability (such as medical equipment ^(Note 1), transport equipment, traffic equipment, aircraft/spacecraft, nuclear power controllers, fuel controllers, car equipment including car accessories, safety devices, etc.) and whose malfunction or failure may cause loss of human life, bodily injury or serious damage to property ("Specific Applications"), please consult with the ROHM sales representative in advance. Unless otherwise agreed in writing by ROHM in advance, ROHM shall not be in any way responsible or liable for any damages, expenses or losses incurred by you or third parties arising from the use of any ROHM's Products for Specific Applications.

(Note1) Medical Equipment Classification of the Specific Applications

JAPAN	USA	EU	CHINA
CLASS III	CLASS III	CLASS II b	CLASS III
CLASS IV		CLASS III	

- ROHM designs and manufactures its Products subject to strict quality control system. However, semiconductor products can fail or malfunction at a certain rate. Please be sure to implement, at your own responsibilities, adequate safety measures including but not limited to fail-safe design against the physical injury, damage to any property, which a failure or malfunction of our Products may cause. The following are examples of safety measures:
 - Installation of protection circuits or other protective devices to improve system safety
 - Installation of redundant circuits to reduce the impact of single or multiple circuit failure
- Our Products are designed and manufactured for use under standard conditions and not under any special or extraordinary environments or conditions, as exemplified below. Accordingly, ROHM shall not be in any way responsible or liable for any damages, expenses or losses arising from the use of any ROHM's Products under any special or extraordinary environments or conditions. If you intend to use our Products under any special or extraordinary environments or conditions (as exemplified below), your independent verification and confirmation of product performance, reliability, etc. prior to use, must be necessary:
 - Use of our Products in any types of liquid, including water, oils, chemicals, and organic solvents
 - Use of our Products outdoors or in places where the Products are exposed to direct sunlight or dust
 - Use of our Products in places where the Products are exposed to sea wind or corrosive gases, including Cl₂, H₂S, NH₃, SO₂, and NO₂
 - Use of our Products in places where the Products are exposed to static electricity or electromagnetic waves
 - Use of our Products in proximity to heat-producing components, plastic cords, or other flammable items
 - Sealing or coating our Products with resin or other coating materials
 - Use of our Products without cleaning residue of flux (even if you use no-clean type fluxes, cleaning residue of flux is recommended); or Washing our Products by using water or water-soluble cleaning agents for cleaning residue after soldering
 - Use of the Products in places subject to dew condensation
- The Products are not subject to radiation-proof design.
- Please verify and confirm characteristics of the final or mounted products in using the Products.
- In particular, if a transient load (a large amount of load applied in a short period of time, such as pulse. is applied, confirmation of performance characteristics after on-board mounting is strongly recommended. Avoid applying power exceeding normal rated power; exceeding the power rating under steady-state loading condition may negatively affect product performance and reliability.
- De-rate Power Dissipation (Pd) depending on Ambient temperature (Ta). When used in sealed area, confirm the actual ambient temperature.
- Confirm that operation temperature is within the specified range described in the product specification.
- ROHM shall not be in any way responsible or liable for failure induced under deviant condition from what is defined in this document.

Precaution for Mounting / Circuit board design

- When a highly active halogenous (chlorine, bromine, etc.) flux is used, the residue of flux may negatively affect product performance and reliability.
- In principle, the reflow soldering method must be used; if flow soldering method is preferred, please consult with the ROHM representative in advance.

For details, please refer to ROHM Mounting specification

Precautions Regarding Application Examples and External Circuits

1. If change is made to the constant of an external circuit, please allow a sufficient margin considering variations of the characteristics of the Products and external components, including transient characteristics, as well as static characteristics.
2. You agree that application notes, reference designs, and associated data and information contained in this document are presented only as guidance for Products use. Therefore, in case you use such information, you are solely responsible for it and you must exercise your own independent verification and judgment in the use of such information contained in this document. ROHM shall not be in any way responsible or liable for any damages, expenses or losses incurred by you or third parties arising from the use of such information.

Precaution for Electrostatic

This Product is electrostatic sensitive product, which may be damaged due to electrostatic discharge. Please take proper caution in your manufacturing process and storage so that voltage exceeding the Products maximum rating will not be applied to Products. Please take special care under dry condition (e.g. Grounding of human body / equipment / solder iron, isolation from charged objects, setting of ionizer, friction prevention and temperature / humidity control).

Precaution for Storage / Transportation

1. Product performance and soldered connections may deteriorate if the Products are stored in the places where:
 - [a] the Products are exposed to sea winds or corrosive gases, including Cl₂, H₂S, NH₃, SO₂, and NO₂
 - [b] the temperature or humidity exceeds those recommended by ROHM
 - [c] the Products are exposed to direct sunshine or condensation
 - [d] the Products are exposed to high Electrostatic
2. Even under ROHM recommended storage condition, solderability of products out of recommended storage time period may be degraded. It is strongly recommended to confirm solderability before using Products of which storage time is exceeding the recommended storage time period.
3. Store / transport cartons in the correct direction, which is indicated on a carton with a symbol. Otherwise bent leads may occur due to excessive stress applied when dropping of a carton.
4. Use Products within the specified time after opening a humidity barrier bag. Baking is required before using Products of which storage time is exceeding the recommended storage time period.

Precaution for Product Label

QR code printed on ROHM Products label is for ROHM's internal use only.

Precaution for Disposition

When disposing Products please dispose them properly using an authorized industry waste company.

Precaution for Foreign Exchange and Foreign Trade act

Since our Products might fall under controlled goods prescribed by the applicable foreign exchange and foreign trade act, please consult with ROHM representative in case of export.

Precaution Regarding Intellectual Property Rights

1. All information and data including but not limited to application example contained in this document is for reference only. ROHM does not warrant that foregoing information or data will not infringe any intellectual property rights or any other rights of any third party regarding such information or data. ROHM shall not be in any way responsible or liable for infringement of any intellectual property rights or other damages arising from use of such information or data.:
2. No license, expressly or implied, is granted hereby under any intellectual property rights or other rights of ROHM or any third parties with respect to the information contained in this document.

Other Precaution

1. This document may not be reprinted or reproduced, in whole or in part, without prior written consent of ROHM.
2. The Products may not be disassembled, converted, modified, reproduced or otherwise changed without prior written consent of ROHM.
3. In no event shall you use in any way whatsoever the Products and the related technical information contained in the Products or this document for any military purposes, including but not limited to, the development of mass-destruction weapons.
4. The proper names of companies or products described in this document are trademarks or registered trademarks of ROHM, its affiliated companies or third parties.

General Precaution

1. Before you use our Products, you are requested to carefully read this document and fully understand its contents. ROHM shall not be in any way responsible or liable for failure, malfunction or accident arising from the use of any ROHM's Products against warning, caution or note contained in this document.
2. All information contained in this document is current as of the issuing date and subject to change without any prior notice. Before purchasing or using ROHM's Products, please confirm the latest information with a ROHM sales representative.
3. The information contained in this document is provided on an "as is" basis and ROHM does not warrant that all information contained in this document is accurate and/or error-free. ROHM shall not be in any way responsible or liable for any damages, expenses or losses incurred by you or third parties resulting from inaccuracy or errors of or concerning such information.