

Thyristor Module

$$V_{RRM} = 2 \times 1600 \text{ V}$$

$$I_{TAV} = 27 \text{ A}$$

$$V_T = 1.27 \text{ V}$$

Phase leg

Part number

MCC26-16io1B

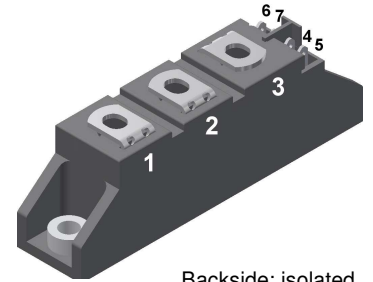

Backside: isolated

E72873

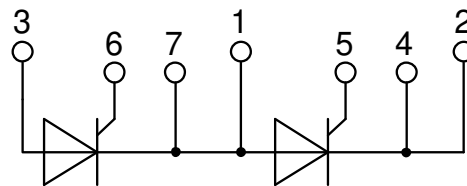

Features / Advantages:

- Thyristor for line frequency
- Planar passivated chip
- Long-term stability
- Direct Copper Bonded Al₂O₃-ceramic

Applications:

- Line rectifying 50/60 Hz
- Softstart AC motor control
- DC Motor control
- Power converter
- AC power control
- Lighting and temperature control

Package: TO-240AA

- Isolation Voltage: 3600 V~
- Industry standard outline
- RoHS compliant
- Soldering pins for PCB mounting
- Base plate: DCB ceramic
- Reduced weight
- Advanced power cycling

Terms and Conditions of Usage

The data contained in this product data sheet is exclusively intended for technically trained staff. The user will have to evaluate the suitability of the product for the intended application and the completeness of the product data with respect to his application. The specifications of our components may not be considered as an assurance of component characteristics. The information in the valid application- and assembly notes must be considered. Should you require product information in excess of the data given in this product data sheet or which concerns the specific application of your product, please contact your local sales office.

Due to technical requirements our product may contain dangerous substances. For information on the types in question please contact your local sales office.

Should you intend to use the product in aviation, in health or life endangering or life support applications, please notify. For any such application we urgently recommend

- to perform joint risk and quality assessments;

- the conclusion of quality agreements;

- to establish joint measures of an ongoing product survey, and that we may make delivery dependent on the realization of any such measures.

Thyristor			Ratings			
Symbol	Definition	Conditions	min.	typ.	max.	Unit
$V_{RSM/DSM}$	max. non-repetitive reverse/forward blocking voltage	$T_{VJ} = 25^{\circ}C$			1700	V
$V_{RRM/DRM}$	max. repetitive reverse/forward blocking voltage	$T_{VJ} = 25^{\circ}C$			1600	V
I_{RD}	reverse current, drain current	$V_{R/D} = 1600 V$	$T_{VJ} = 25^{\circ}C$		100	μA
		$V_{R/D} = 1600 V$	$T_{VJ} = 125^{\circ}C$		3	mA
V_T	forward voltage drop	$I_T = 40 A$	$T_{VJ} = 25^{\circ}C$		1.27	V
		$I_T = 80 A$			1.64	V
		$I_T = 40 A$	$T_{VJ} = 125^{\circ}C$		1.27	V
		$I_T = 80 A$			1.65	V
I_{TAV}	average forward current	$T_C = 85^{\circ}C$	$T_{VJ} = 125^{\circ}C$		27	A
$I_{T(RMS)}$	RMS forward current	180° sine			42	A
V_{T0}	threshold voltage	} for power loss calculation only	$T_{VJ} = 125^{\circ}C$		0.85	V
r_T	slope resistance				11	m Ω
R_{thJC}	thermal resistance junction to case				0.88	K/W
R_{thCH}	thermal resistance case to heatsink			0.20		K/W
P_{tot}	total power dissipation		$T_C = 25^{\circ}C$		115	W
I_{TSM}	max. forward surge current	$t = 10 ms$; (50 Hz), sine	$T_{VJ} = 45^{\circ}C$		520	A
		$t = 8,3 ms$; (60 Hz), sine	$V_R = 0 V$		560	A
		$t = 10 ms$; (50 Hz), sine	$T_{VJ} = 125^{\circ}C$		440	A
		$t = 8,3 ms$; (60 Hz), sine	$V_R = 0 V$		475	A
I^2t	value for fusing	$t = 10 ms$; (50 Hz), sine	$T_{VJ} = 45^{\circ}C$		1.35	kA ² s
		$t = 8,3 ms$; (60 Hz), sine	$V_R = 0 V$		1.31	kA ² s
		$t = 10 ms$; (50 Hz), sine	$T_{VJ} = 125^{\circ}C$		970	A ² s
		$t = 8,3 ms$; (60 Hz), sine	$V_R = 0 V$		940	A ² s
C_J	junction capacitance	$V_R = 400 V$ $f = 1 MHz$	$T_{VJ} = 25^{\circ}C$		22	pF
P_{GM}	max. gate power dissipation	$t_p = 30 \mu s$	$T_C = 125^{\circ}C$		10	W
		$t_p = 300 \mu s$			5	W
P_{GAV}	average gate power dissipation				0.5	W
$(di/dt)_{cr}$	critical rate of rise of current	$T_{VJ} = 125^{\circ}C$; $f = 50 Hz$ repetitive, $I_T = 45 A$			150	A/ μs
		$t_p = 200 \mu s$; $di_G/dt = 0.45 A/\mu s$; $I_G = 0.45 A$; $V = \frac{2}{3} V_{DRM}$ non-repet., $I_T = 27 A$			500	A/ μs
$(dv/dt)_{cr}$	critical rate of rise of voltage	$V = \frac{2}{3} V_{DRM}$ $R_{GK} = \infty$; method 1 (linear voltage rise)	$T_{VJ} = 125^{\circ}C$		1000	V/ μs
V_{GT}	gate trigger voltage	$V_D = 6 V$	$T_{VJ} = 25^{\circ}C$		1.5	V
			$T_{VJ} = -40^{\circ}C$		1.6	V
I_{GT}	gate trigger current	$V_D = 6 V$	$T_{VJ} = 25^{\circ}C$		100	mA
			$T_{VJ} = -40^{\circ}C$		200	mA
V_{GD}	gate non-trigger voltage	$V_D = \frac{2}{3} V_{DRM}$	$T_{VJ} = 125^{\circ}C$		0.2	V
I_{GD}	gate non-trigger current				10	mA
I_L	latching current	$t_p = 10 \mu s$	$T_{VJ} = 25^{\circ}C$		450	mA
		$I_G = 0.45 A$; $di_G/dt = 0.45 A/\mu s$				
I_H	holding current	$V_D = 6 V$ $R_{GK} = \infty$	$T_{VJ} = 25^{\circ}C$		200	mA
t_{gd}	gate controlled delay time	$V_D = \frac{1}{2} V_{DRM}$ $I_G = 0.45 A$; $di_G/dt = 0.45 A/\mu s$	$T_{VJ} = 25^{\circ}C$		2	μs
t_q	turn-off time	$V_R = 100 V$; $I_T = 20 A$; $V = \frac{2}{3} V_{DRM}$ $di/dt = 10 A/\mu s$ $dv/dt = 20 V/\mu s$ $t_p = 200 \mu s$	$T_{VJ} = 100^{\circ}C$		150	μs

Package TO-240AA				Ratings		
Symbol	Definition	Conditions	min.	typ.	max.	Unit
I_{RMS}	RMS current	per terminal			200	A
T_{VJ}	virtual junction temperature		-40		125	°C
T_{op}	operation temperature		-40		100	°C
T_{stg}	storage temperature		-40		125	°C
Weight					81	g
M_D	mounting torque		2.5		4	Nm
M_T	terminal torque		2.5		4	Nm
$d_{Spp/App}$	creepage distance on surface striking distance through air	terminal to terminal	13.0	9.7		mm
$d_{Spb/Apb}$		terminal to backside	16.0	16.0		mm
V_{ISOL}	isolation voltage	t = 1 second		3600		V
		t = 1 minute	50/60 Hz, RMS; $I_{ISOL} \leq 1$ mA	3000		V



Ordering	Ordering Number	Marking on Product	Delivery Mode	Quantity	Code No.
Standard	MCC26-16io1B	MCC26-16io1B	Box	36	452866

Similar Part	Package	Voltage class
MCMA35P1600TA	TO-240AA-1B	1600
MCMA50P1600TA	TO-240AA-1B	1600

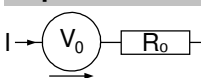
Equivalent Circuits for Simulation
** on die level*
 $T_{VJ} = 125^\circ\text{C}$

Thyristor

$V_{0\ max}$	threshold voltage	0.85	V
$R_{0\ max}$	slope resistance *	9.8	mΩ

Outlines TO-240AA

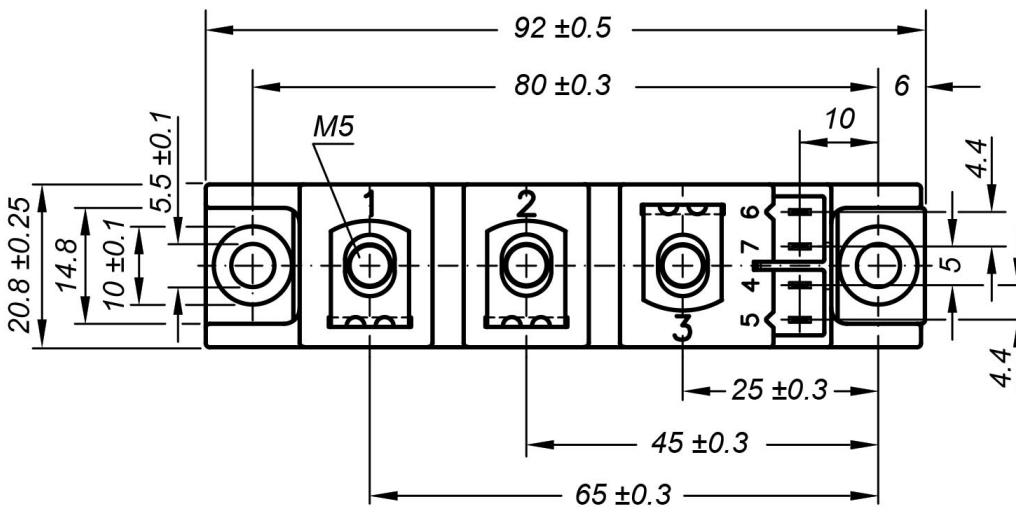

General tolerance: DIN ISO 2768 class „c“



Optional accessories: Keyed gate/cathode twin plugs
 Wire length: 350 mm, gate = white, cathode = red
 UL 758, style 3751
 Type **ZY 200L** (L = Left for pin pair 4/5)
 Type **ZY 200R** (R = Right for pin pair 6/7)

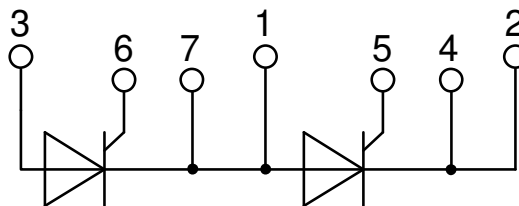

Thyristor

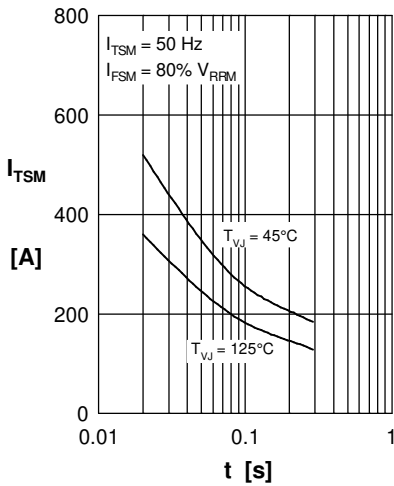

Fig. 1 Surge overload current I_{TSM} , I_{FSM} : Crest value, t: duration

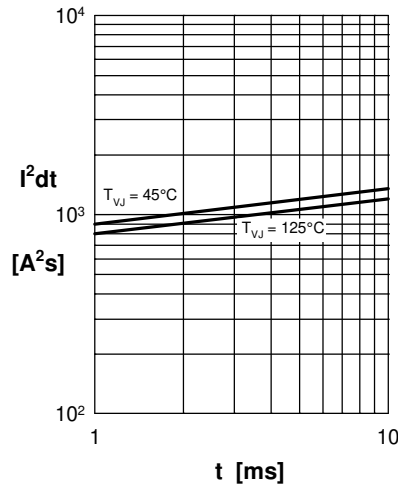

Fig. 2 I^2dt versus time (1-10 ms)

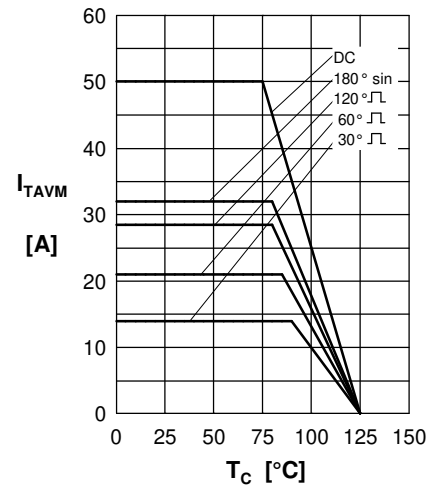

Fig. 3 Max. forward current at case temperature

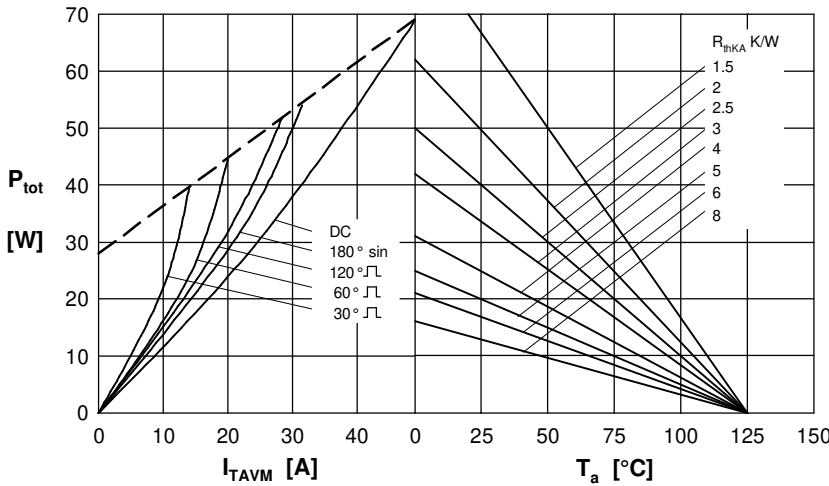

Fig. 4 Power dissipation vs. on-state current & ambient temperature (per thyristor or diode)

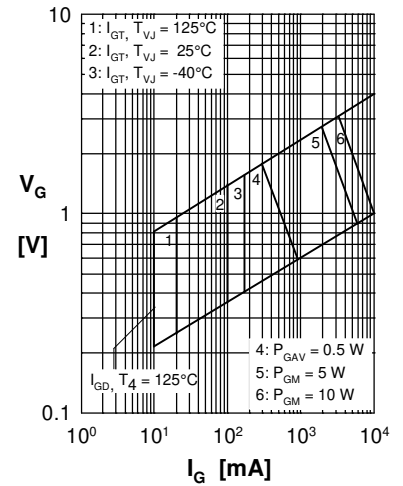

Fig. 5 Gate trigger characteristics

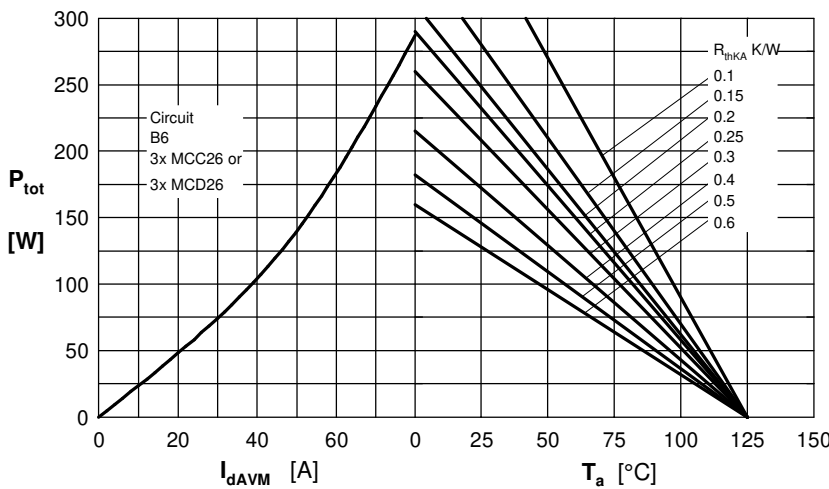

Fig. 6 Three phase rectifier bridge: Power dissipation versus direct output current and ambient temperature

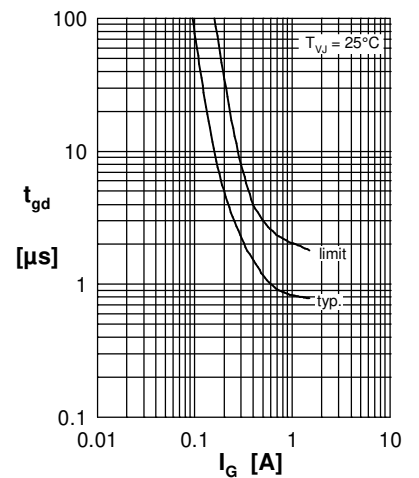

Fig. 7 Gate trigger delay time

Thyristor

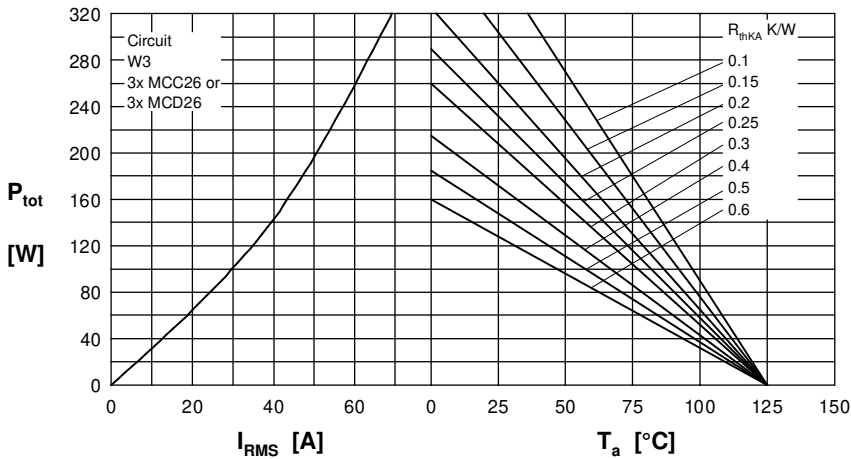
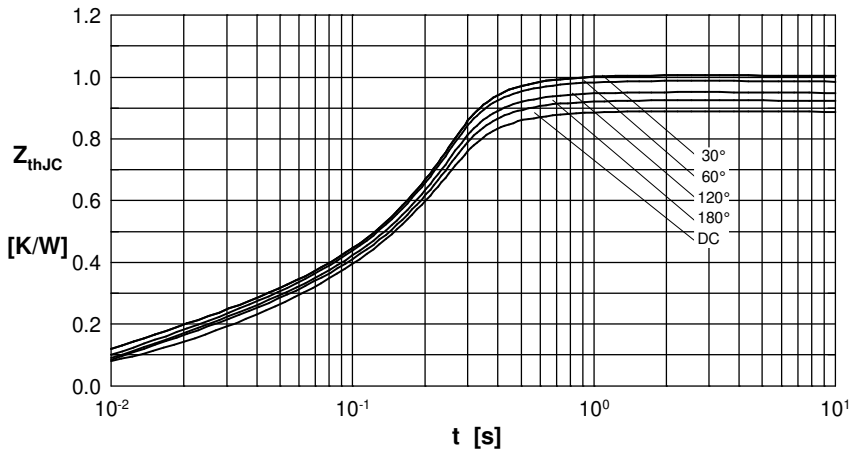

Fig. 8 Three phase AC-controller: Power dissipation versus RMS output current and ambient temperature



R_{thJC} for various conduction angles d:

d	R_{thJC} [K/W]
DC	0.88
180°	0.92
120°	0.95
60°	0.98
30°	1.01

Constants for Z_{thJC} calculation:

i	R_{thi} [K/W]	t_i [s]
1	0.019	0.0031
2	0.029	0.0216
3	0.832	0.1910

Fig. 9 Transient thermal impedance junction to case (per thyristor/diode)

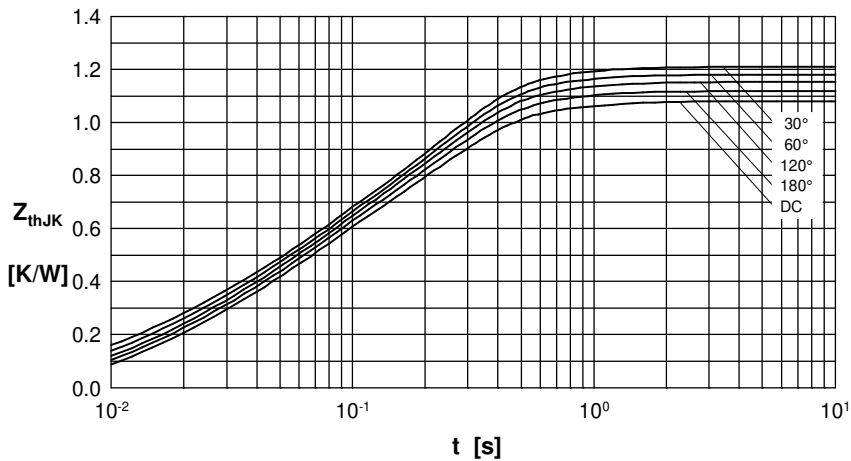

R_{thJK} for various conduction angles d:

d	R_{thJK} [K/W]
DC	1.08
180°	1.12
120°	1.15
60°	1.18
30°	1.21

Constants for Z_{thJK} calculation:

i	R_{thi} [K/W]	t_i [s]
1	0.019	0.0031
2	0.029	0.0216
3	0.832	0.1910
4	0.200	0.4500

Fig. 10 Transient thermal impedance junction to heatsink (per thyristor/diode)