

Measurement condition

Ambient temperature:	23	°C
Input power level:	0	dBm
Terminating impedance:		
Input:	50	Ω
Output:	50	Ω

Characteristics

Remark:

The maximum attenuation within passband 1 is defined as the insertion loss a_e . The nominal frequency f_N is fixed at 706 MHz without any tolerance or limit. The values of absolute attenuation a_{abs} are guaranteed for the whole operating temperature range. The frequency shift of the filter in the operating temperature range is included in the production tolerance scheme.

D a t a	typ. value		tolerance / limit	
Nominal frequency	f_N		706	MHz
Passband 1	PB1		$f_N \pm 12.0$	MHz
Insertion loss within PB1	a_e	2.1 dB	max. 3.0	dB
Passband 2	PB2		$f_N \pm 15.0$	MHz
Insertion loss within PB2		2.4 dB	max. 4.0	dB
Passband variation within PB2		0.6 dB	max. 2.0	dB
Absolute attenuation	a_{abs}			
$f_N \pm 80$ MHz ... $f_N \pm 149$ MHz		45 dB	min. 33.5	dB
$f_N + 149$ MHz ... $f_N + 300$ MHz		48 dB	min. 45.0	dB
1 MHz ... 200 MHz		58 dB	min. 50.0	dB
200 MHz ... $f_N - 149$ MHz		65 dB	min. 55.0	dB
Group delay ripple within PB1	p-p	10 ns	max. 0.2	μs
IIP3	*	-	min. 36	dBm
Input power level		-	max. 10	dBm
Operating temperature range	OTR	-	- 10 °C ... + 75 °C	
Storage temperature range		-	- 40 °C ... + 85 °C	
Temperature coefficient of frequency	TC_f **	-76 ppm/K		

*) $f_{in1} = f_C - 14$ MHz; $f_{in2} = f_C - 14.4$ MHz; $P_{in} = 0$ dBm; $f_{measurement1} = f_C - 13.6$ MHz; $f_{measurement2} = f_C - 14.8$ MHz. The centre frequency f_C is the arithmetic mean value of the upper and lower frequencies at the 3 dB filter attenuation level relative to the insertion loss a_e .

***) $\Delta f(\text{Hz}) = TC_f (\text{ppm/K}) \times (T - T_0) \times f_{T0} (\text{MHz})$

Generated:**Checked / Approved:**

Vectron International GmbH
Potsdamer Straße 18
D 14 513 TELTOW / Germany
Tel: (+49) 3328 4784-0 / Fax: (+49) 3328 4784-30
E-Mail: tft@vectron.com

Vectron International GmbH reserves the right to make changes to the product(s) and/or information contained herein without notice. No liability is assumed as a result of their use or application. No rights under any patent accompany the sale of any such product(s) or information.

Filter characteristic

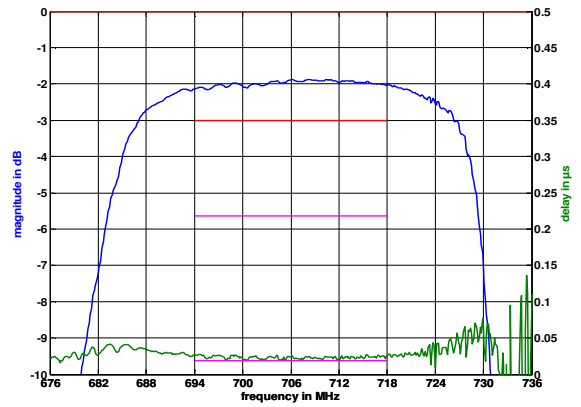
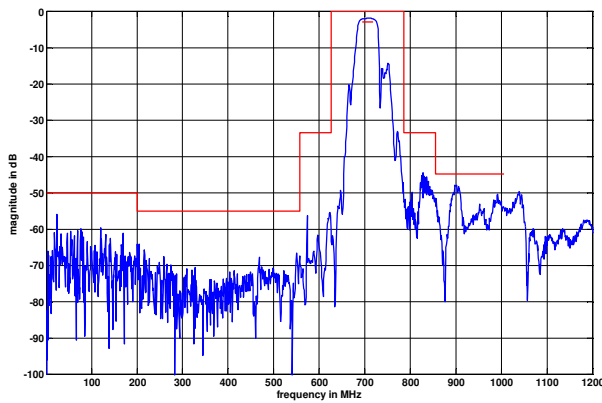

Construction and pin connection

(All dimensions in mm)

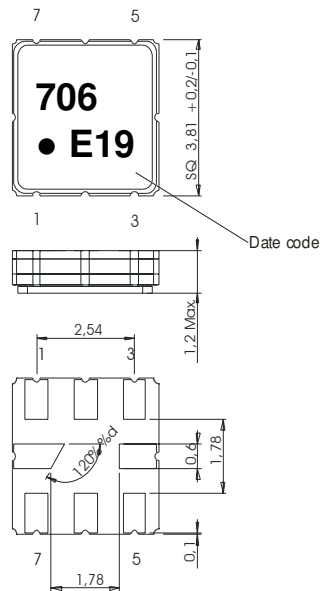

- 1 Ground
- 2 Input
- 3 Ground
- 4 Ground
- 5 Ground
- 6 Output
- 7 Ground
- 8 Ground

Date code: Year + week
 E 2014
 F 2015
 G 2016
 ...

50 Ω Test circuit

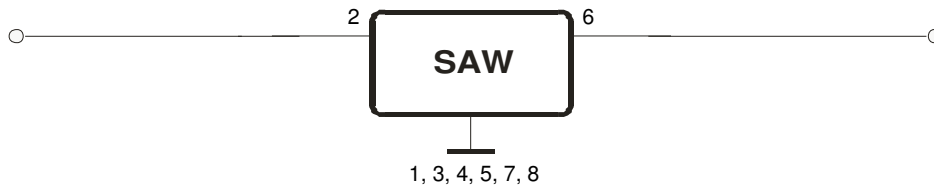

Vectron International GmbH
 Potsdamer Straße 18
 D 14 513 TELTOW / Germany
 Tel: (+49) 3328 4784-0 / Fax: (+49) 3328 4784-30
 E-Mail: tft@vectron.com

Vectron International GmbH reserves the right to make changes to the product(s) and/or information contained herein without notice. No liability is assumed as a result of their use or application. No rights under any patent accompany the sale of any such product(s) or information.

Stability characteristics, reliability

After the following tests the filter shall meet the whole specification:

1. Shock: 500g, 1 ms, half sine wave, 3 shocks each plane;
DIN IEC 68 T2 - 27
2. Vibration: 10 Hz to 500 Hz, 0.35 mm or g respectively, 1 octave per min, 10 cycles per plane, 3 planes; DIN IEC 68 T2 - 6
3. Change of temperature: -55 °C to 125°C / 15 min. each / 100 cycles
DIN IEC 68 part 2 – 14 Test N
4. Resistance to solder heat (reflow): reflow possible: three times max.;
for temperature conditions, see page 4: "Air reflow temperature conditions"

This filter is RoHS compliant (2011/65/EU)

Packing

Tape & Reel: IEC 286 – 3, with exception of value for N and minimum bending radius;
tape type II, embossed carrier tape with top cover tape on the upper side;

max. pieces of filters per reel:	3000
reel of empty components at start:	min. 300 mm
reel of empty components at start including leader:	min. 500 mm
trailer:	min. 300 mm

Tape (all dimensions in mm)

- W : 12,00 ± 0,3
- Po : 4,00 ± 0,1
- Do : 1,50 +0,1/-0
- E : 1,75 ± 0,1
- F : 5,50 ± 0,05
- G(min) : 0,75
- P2 : 2,00 ± 0,05
- P1 : 8,00 ± 0,1
- D1(min) : 1,50
- Ao : 4,30 ± 0,1
- Bo : 4,30 ± 0,1
- Ct : 9,2 ± 0,1

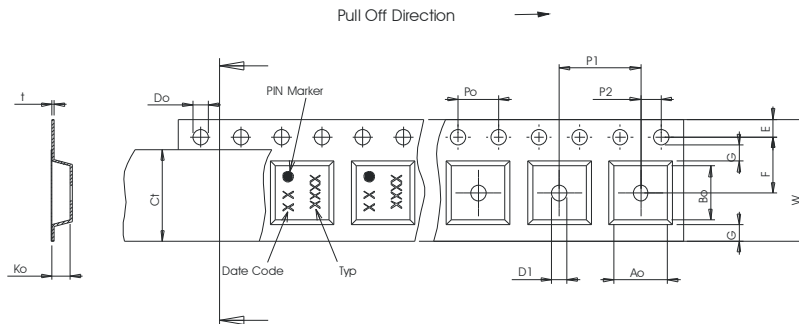

Reel (all dimensions in mm)

- A : 330
- W1 : 12,4 +2/-0
- W2(max) : 18,4
- N(min) : 50
- C : 13,0 +0,5/-0,2

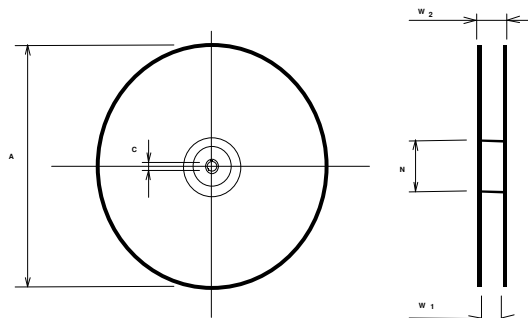

The minimum bending radius is 45 mm.

Vectron International GmbH
Potsdamer Straße 18
D 14 513 TELTOW / Germany
Tel: (+49) 3328 4784-0 / Fax: (+49) 3328 4784-30
E-Mail: tft@vectron.com

Vectron International GmbH reserves the right to make changes to the product(s) and/or information contained herein without notice. No liability is assumed as a result of their use or application. No rights under any patent accompany the sale of any such product(s) or information.

Air reflow temperature conditions

Conditions	Exposure
Average ramp-up rate (30°C to 217°C)	less than 3°C/second
> 100°C	between 300 and 600 seconds
> 150°C	between 240 and 500 seconds
> 217°C	between 30 and 150 seconds
Peak temperature	max. 260°C
Time within 5°C of actual peak temperature	between 10 and 30 seconds
Cool-down rate (Peak to 50°C)	less than 6°C/second
Time from 30°C to Peak temperature	no greater than 300 seconds

Chip-mount air reflow profile

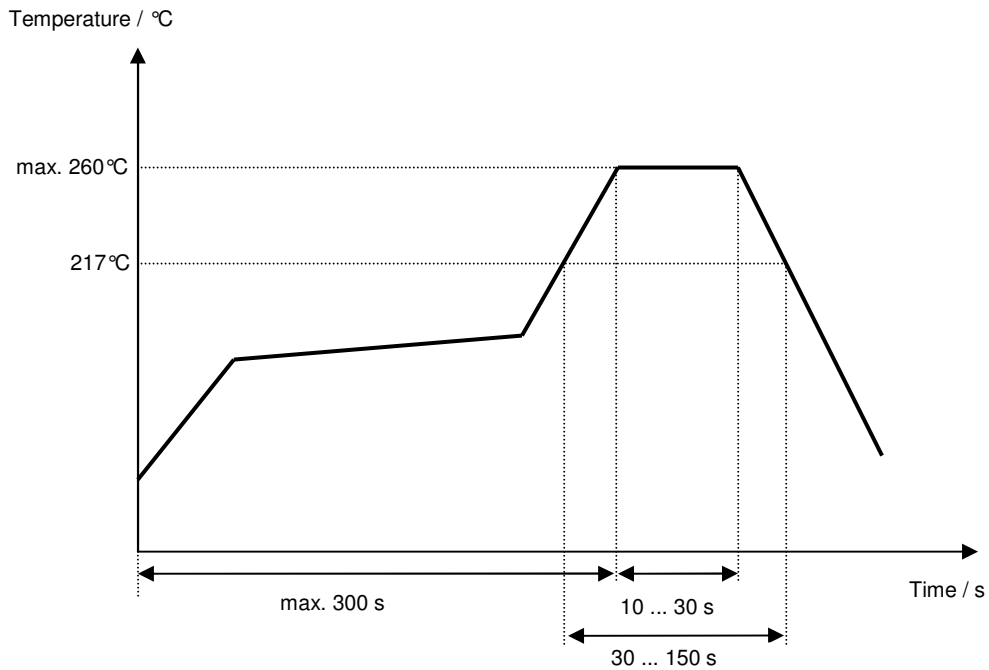

Vectron International GmbH
 Potsdamer Straße 18
 D 14 513 TELTOW / Germany
 Tel: (+49) 3328 4784-0 / Fax: (+49) 3328 4784-30
 E-Mail: tft@vectron.com

Vectron International GmbH reserves the right to make changes to the product(s) and/or information contained herein without notice. No liability is assumed as a result of their use or application. No rights under any patent accompany the sale of any such product(s) or information.

History

Version	Reason of Changes	Name	Date
1.0	- Generation of development specification	Springfeldt	14.04.2004
1.1	- Change of absolute attenuation $f_N + 149 \dots 300$ MHz - Change insertion loss	Strehl	20.01.2005
1.2	- Add typical values and filter characteristic - Generation of filter specification	Strehl	22.06.2005
1.3	- Add IIP3 and change stability characteristics	Strehl	19.07.2006
2.0	- Additional passband with larger bandwidth specified - Orientation of tape and reel updated - Typos corrected	Molke	07.05.2014