



### Features

- 2.5A Maximum Peak Output Current
- 25kV/ $\mu$ s Minimum Common Mode Rejection (CMR) at 1500V<sub>CM</sub>
- Wide Operating Voltage Range: 15V to 30V
- Under Voltage Lockout with Hysteresis
- 3750V<sub>rms</sub> Input to Output Isolation
- Wide Temperature Range: -40°C to +100°C

### Applications

- Isolated IGBT/MOSFET Gate Drive
- Switch Mode Power Supplies
- Industrial Inverters
- Motor Drivers

### Description

The IX3120 gate driver includes an input infrared LED that is optically coupled to a power output stage. The power output stage is capable of sourcing or sinking 2A of peak current, which is ideal for driving IGBTs and MOSFETs in the mid-power range.

The gate driver optocoupler with its low input LED current, high output peak current, and high noise immunity (25kV/ $\mu$ s) is ideally suited for use in motor control and inverter applications.

The IX3120 is provided in an 8-pin DIP package and an 8-pin surface mount package.

### Approvals

- UL Recognized Component: File E76270
- IEC/EN/DIN EN 60747-5-5 ("GE" Versions)

### Ordering Information

Part	Description
IX3120G	8-Pin DIP Package (50/Tube)
IX3120GS	8-Pin Surface Mount (50/Tube)
IX3120GSTR	8-Pin Surface Mount Tape & Reel (1000/Reel)
IX3120GE	8-Pin DIP Package (50/Tube), IEC 60747-5-5 Option
IX3120GES	8-Pin Surface Mount (50/Tube), IEC 60747-5-5 Option
IX3120GESTR	8-Pin Surface Mount Tape & Reel (1000/Reel), IEC 60747-5-5 Option

Figure 1. IX3120 Block Diagram



TRUTH TABLE

LED	$V_{CC}-V_{EE}$ Positive Going (i.e. Turn-On)	$V_{CC}-V_{EE}$ Negative Going (i.e. Turn-Off)	$V_o$
OFF	0V - 30V	0V - 30V	LOW
ON	0V - 11V	0V - 9.5V	LOW
ON	11V - 13.5V	9.5V - 12V	TRANSITION
ON	13.5V - 30V	12V - 30V	HIGH

**Note:** A 0.1 $\mu$ F bypass capacitor must be connected between pins 5 and 8.



<b>1. Specifications</b> .....	<b>3</b>
1.1 Package Pinout .....	3
1.2 Pin Description .....	3
1.3 Absolute Maximum Ratings .....	3
1.4 Recommended Operating Conditions .....	4
1.5 Electrical Specifications (DC) .....	4
1.6 Switching Characteristics (AC) .....	5
1.7 Safety and Insulation Ratings .....	6
<b>2. Performance Data</b> .....	<b>7</b>
<b>3. Test Circuits</b> .....	<b>9</b>
<b>4. Manufacturing Information</b> .....	<b>10</b>
4.1 Moisture Sensitivity .....	10
4.2 ESD Sensitivity .....	10
4.3 Soldering Profile .....	10
4.4 Board Wash .....	10
4.5 Package Mechanical Dimensions .....	11
4.5.1 IX3120G & IX3120GE 8-Pin DIP .....	11
4.5.2 IX3120GS & IX3120GES 8-Pin Surface Mount .....	11
4.5.3 IX3120GSTR & IX3120GESTR Tape & Reel .....	12
4.6 Device Branding .....	12

## 1. Specifications

### 1.1 Package Pinout



### 1.2 Pin Description

Pin#	Name	Description
1	N/C	No connection
2	ANODE	Anode of input LED
3	CATHODE	Cathode of input LED
4	N/C	No connection
5	$V_{EE}$	Negative Supply Voltage
6	$V_O$	Gate Drive Output
7	$V_O$	Gate Drive Output
8	$V_{CC}$	Positive Supply Voltage

### 1.3 Absolute Maximum Ratings

Absolute maximum ratings are at 25°C.

Parameter	Symbol	Limit	Units
Supply Voltage	$V_{CC} - V_{EE}$	0 to 35	V
Output Voltage	$V_{O(PEAK)}$	0 to $V_{CC}$	V
“High” Peak Output Current <sup>1</sup>	$I_{OH(PEAK)}$	- 2.5	A
“Low” Peak Output Current <sup>1</sup>	$I_{OL(PEAK)}$	2.5	A
Reverse Input Voltage	$V_R$	5	V
Average Input Current	$I_{F(AVG)}$	20	mA
Peak Transient Input Current (<1µs pulse width, 300pps)	$I_{F(TRAN)}$	1	A
Input Power Dissipation <sup>2</sup>	$P_{IN}$	50	mW
Total Power Dissipation <sup>3</sup>	$P_T$	800	mW
Isolation Voltage, Input to Output	$V_{IO}$	3750	$V_{rms}$
Operating Temperature	$T_A$	-40 to +100	°C
Storage Temperature	$T_{STG}$	-55 to +125	°C

Notes:

<sup>1</sup> Maximum pulse width=10µs, maximum duty cycle=0.2%.

<sup>2</sup> Derate linearly 1.33mW/°C

<sup>3</sup> Derate linearly 7.5mW/°C

*Absolute maximum ratings are stress ratings. Stresses in excess of these ratings can cause permanent damage to the device. Functional operation of the device at conditions beyond those indicated in the operational sections of this data sheet is not implied.*

### 1.4 Recommended Operating Conditions

Parameter	Symbol	Min	Max	Units
Power Supply Voltage	$V_{CC} - V_{EE}$	15	30	V
Input Current (ON)	$I_{F(on)}$	7	16	mA
Input Voltage (OFF)	$V_{F(off)}$	-3.6	0.8	V
Operating Temperature	$T_A$	-40	100	°C

### 1.5 Electrical Specifications (DC)

Over recommended operating conditions unless otherwise specified. Typical values are at  $T_A=25^{\circ}\text{C}$ ,  $V_{CC}=30\text{V}$ , and  $V_{EE}=\text{Ground}$ .

Parameter	Conditions	Symbol	Min	Typ	Max	Units
High Level Output Current	$V_O=(V_{CC}-4\text{V})^1$	$I_{OH}$	-0.5	-1.5	-	A
	$V_O=(V_{CC}-15\text{V})^2$		-2	-	-	
Low Level Output Current	$V_O=(V_{EE}+2.5\text{V})^1$	$I_{OL}$	0.5	1.4	-	A
	$V_O=(V_{EE}+15\text{V})^2$		2	-	-	
High Level Output Voltage	$I_O=100\text{mA}$	$V_{OH}$	$V_{CC}-4$	$V_{CC}-0.5$	-	V
Low Level Output Voltage	$I_O=100\text{mA}$	$V_{OL}$	-	0.1	0.5	V
High Level Supply Current	Output Open, $I_F=7$ to $16\text{mA}$	$I_{CCH}$	-	4.5	6	mA
Low Level Supply Current	Output Open, $V_F=-3$ to $+0.8\text{V}$	$I_{CCL}$	-	2.6	6	
Threshold Input Current, Low-to-High	$I_O=0\text{mA}$ , $V_O>5\text{V}$	$I_{FLH}$	-	0.7	5	mA
Threshold Input Voltage, High-to-Low	-	$V_{FHL}$	0.8	-	-	V
Input Forward Voltage	$I_F=10\text{mA}$	$V_F$	1	1.24	1.5	V
Temperature Coefficient of Forward Voltage	$I_F=10\text{mA}$	$\Delta V_F/\Delta T_A$	-	-1.6	-	mV/°C
Input Reverse Breakdown Voltage	$I_R=10\mu\text{A}$	$BV_R$	5	-	-	V
Input Capacitance	$f=1\text{MHz}$ , $V_F=0\text{V}$	$C_{IN}$	-	60	-	pF
UVLO Threshold	$V_O>5\text{V}$ , $I_F=10\text{mA}$	$V_{UVLO+}$	11	12.3	13.5	V
		$V_{UVLO-}$	9.5	10.7	12	
UVLO Hysteresis	$V_O>5\text{V}$ , $I_F=10\text{mA}$	$UVLO_{HYS}$	-	1.6	-	V

<sup>1</sup> Maximum pulse width =  $50\mu\text{s}$ , maximum duty cycle = 0.5%.

<sup>2</sup> Maximum pulse width =  $10\mu\text{s}$ , maximum duty cycle = 0.2%.

See “Test Circuits” on page 9 for more information.

### 1.6 Switching Characteristics (AC)

Over recommended operating conditions, unless otherwise specified.

Parameter	Conditions	Symbol	Min	Typ	Max	Units
Propagation Delay Time to High Output Level	$R_G=10\Omega$ , $C_G=10nF$ $f=10kHz$ , Duty Cycle=50%	$t_{PLH}$	0.1	0.3	0.5	$\mu s$
Propagation Delay Time to Low Output Level		$t_{PHL}$	0.1	0.3	0.5	
Pulse Width Distortion		PWD $ t_{PHL}-t_{PLH} $	-	-	0.3	
Propagation Delay Difference Between any Two Parts <sup>1</sup>		PDD $(t_{PHL}-t_{PLH})$	-0.35	-	0.35	
Rise Time		$t_r$	-	0.1	-	
Fall Time		$t_f$	-	0.1	-	
UVLO Turn-On Delay		$V_O>5V$ , $I_F=10mA$	$t_{UVLO(on)}$	-	0.8	
UVLO Turn-Off Delay	$V_O<5V$ , $I_F=10mA$	$t_{UVLO(off)}$	-	0.6	-	
Output High Level Common Mode Transient Immunity	$I_F=10$ to $16mA$ , $V_{CM}=1500V$ , $V_{CC}=30V$ , $T_A=25^\circ C$	$ CM_H $	25	35	-	kV/ $\mu s$
Output Low Level Common Mode Transient Immunity	$V_F=0V$ , $V_{CM}=1500V$ , $V_{CC}=30V$ , $T_A=25^\circ C$	$ CM_L $	25	35	-	

<sup>1</sup> The difference between  $t_{PHL}$  and  $t_{PLH}$  of any two IX3120 devices operating under the same conditions and temperature.

Figure 2. Timing Waveforms



## 1.7 Safety and Insulation Ratings

As per IEC 60747-5-5.

Parameter	Conditions	Symbol	Rating	Units
Minimum External Air Gap (Clearance)	Measured from input terminals to output terminals, shortest distance through air.	L(101)	7.62	mm
Minimum External Tracking (Creepage)	Measured from input terminals to output terminals, shortest distance path along body.	L(102)	7.50	mm
Distance Through Insulation (Internal Clearance)	Insulation thickness between emitter and detector	-	0.48	mm
Tracking Resistance (Comparative Tracking Index)	DIN IEC 60112/VDE 0303 Part 1	CTI	>175	V
Isolation Group	DIN VDE 0110, 1/89, Table 1 Material Group	-	IIIa	-
Installation classification	DIN VDE 0110/1.89, Table 1 Rated mains voltage $\leq 300V_{rms}$	-	I-IV	-
	DIN VDE 0110/1.89, Table 1 Rated mains voltage $\leq 1000V_{rms}$	-	I-III	-
Climatic Classification	-	-	55/100/21	-
Input to Output Test Voltage	IEC EN 60747-5-5 Method b, $V_{IORM} \times 1.875 = V_{PR}$ , 100% Production Test with $t_m = 1$ sec., Partial Discharge $< 5pC$	$V_{PR}$	3750	$V_{PEAK}$
	IEC EN 60747-5-5 Method a, $V_{IORM} \times 1.6 = V_{PR}$ , Type and Sample Test with $t_m = 10$ sec., Partial Discharge $< 5pC$		3200	
Insulation Resistance	$T_S, V_{IO} = 500V_{DC}$	$R_S$	$10^9$	$\Omega$
Pollution Degree	DIN VDE 0109	-	2	-
Highest Allowable Over-Voltage	Transient Over-Voltage	$V_{IOTM}$	6000	$V_P$
Maximum Working Insulation Voltage	Recurring Voltage	$V_{IORM}$	2000	$V_P$
Partial Discharge Test Voltage	DIN EN 60747-5-5 Method B	$V_{PR}$	3750	$V_P$
Isolation Test Voltage	-	$V_{ISO}$	3750	$V_{rms}$
Input-Output Momentary Withstand Voltage	RH $< 50\%$ , $t = 1$ min, $T_A = 25^\circ C$	$V_{ISO}$	3750	$V_{rms}$
Resistance (Input-Output), Typical	$V_{I-O} = 500V_{DC}$	$R_{I-O}$	$10^{12}$	$\Omega$
Capacitance (Input-Output), Typical	$f = 1$ MHz	$C_{I-O}$	0.6	pF

## 2. Performance Data

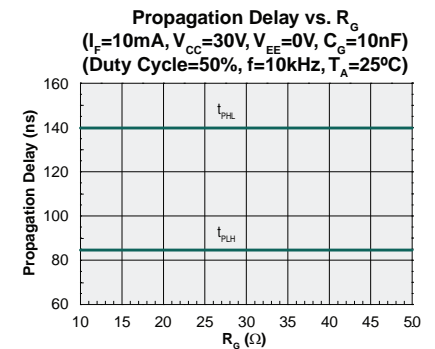
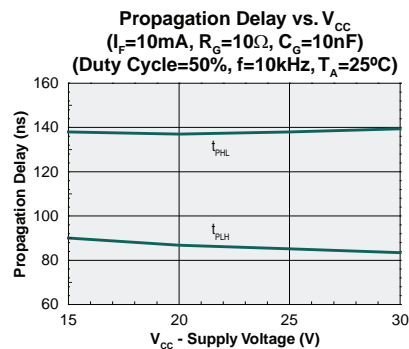
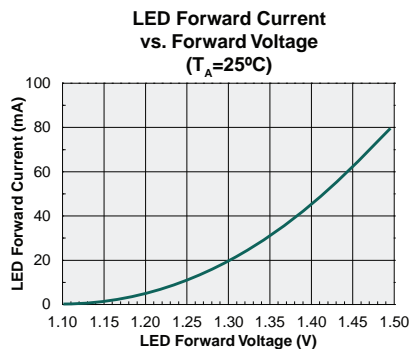
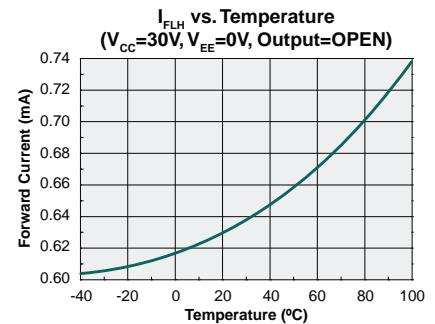
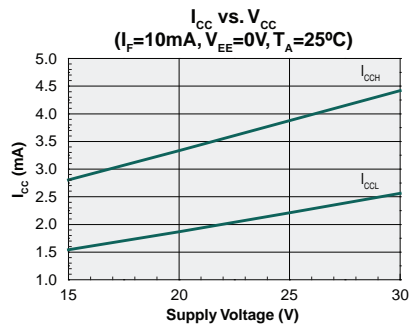
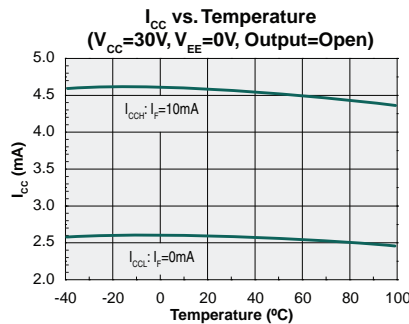
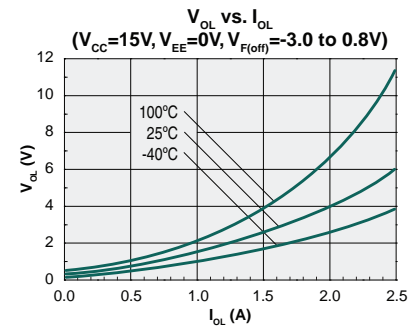
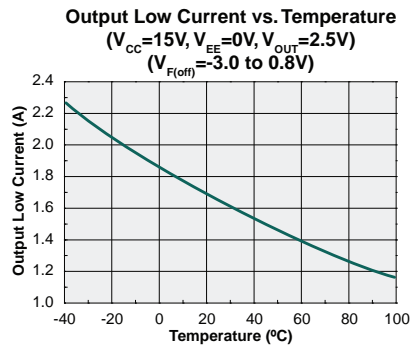
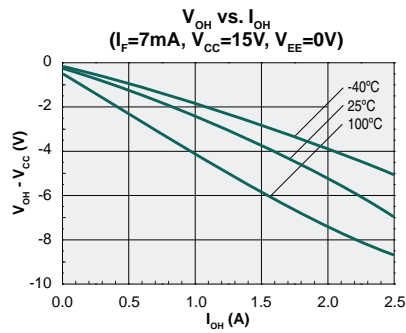
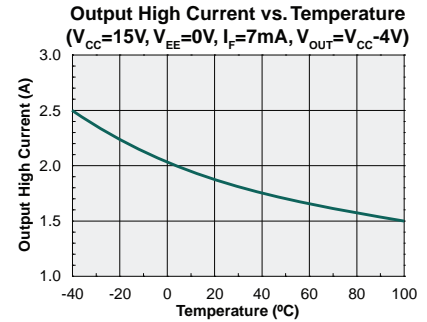
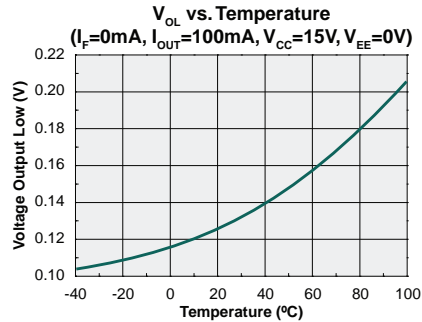
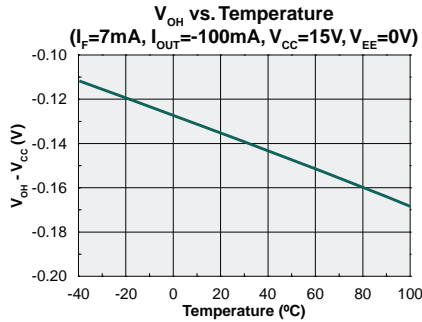

Performance Data (Cont.)

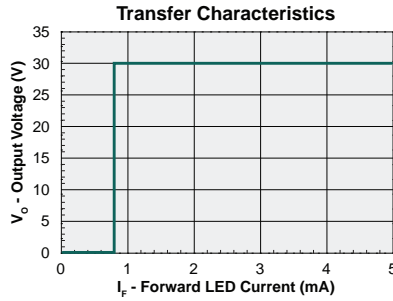
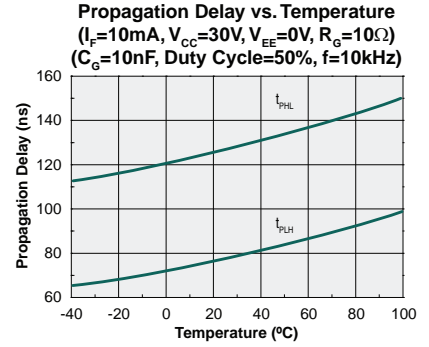
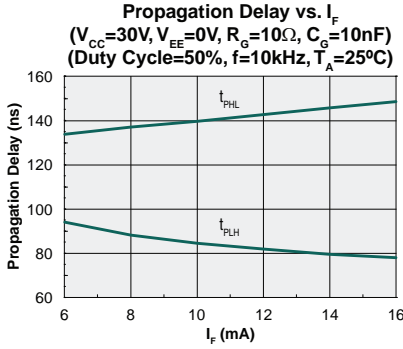



### 3. Test Circuits

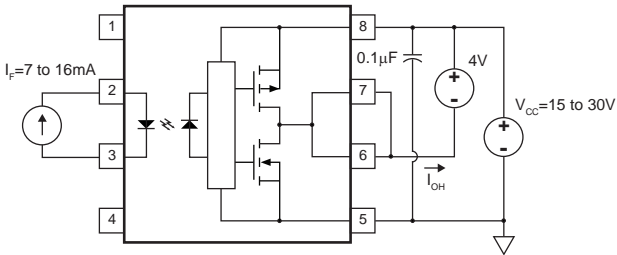

$I_{OH}$  Test Circuit

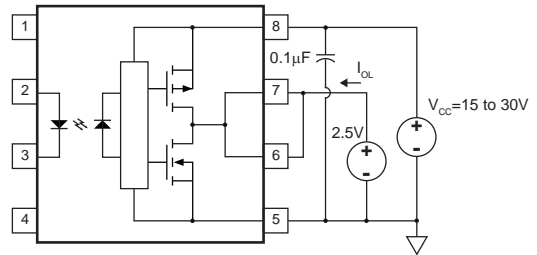

$I_{OL}$  Test Circuit

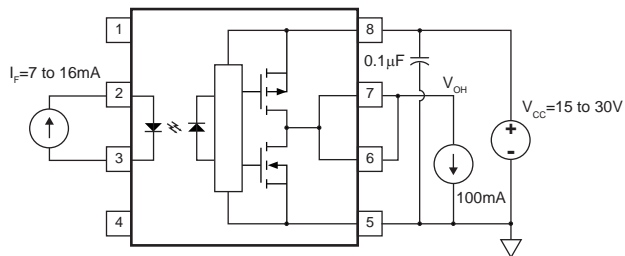

$V_{OH}$  Test Circuit

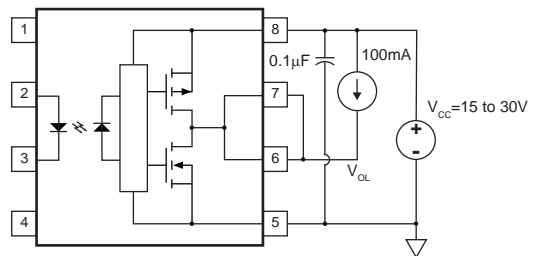

$V_{OL}$  Test Circuit



$I_{FLH}$  Test Circuit



UVLO Test Circuit



$t_{PLH}$ ,  $t_{PHL}$ ,  $t_r$ ,  $t_f$  Test Circuit

## 4. Manufacturing Information

### 4.1 Moisture Sensitivity



All plastic encapsulated semiconductor packages are susceptible to moisture ingress. IXYS Integrated Circuits Division classifies its plastic encapsulated devices for moisture sensitivity according to the latest version of the joint industry standard, **IPC/JEDEC J-STD-020**, in force at the time of product evaluation.

We test all of our products to the maximum conditions set forth in the standard, and guarantee proper operation of our devices when handled according to the limitations and information in that standard as well as to any limitations set forth in the information or standards referenced below.

Failure to adhere to the warnings or limitations as established by the listed specifications could result in reduced product performance, reduction of operable life, and/or reduction of overall reliability.

This product carries a **Moisture Sensitivity Level (MSL)** classification as shown below, and should be handled according to the requirements of the latest version of the joint industry standard **IPC/JEDEC J-STD-033**.

Device	Moisture Sensitivity Level (MSL) Classification
IX3120G / IX3120GS / IX3120GE / IX3120GES	MSL 1

### 4.2 ESD Sensitivity



This product is **ESD Sensitive**, and should be handled according to the industry standard **JESD-625**.

### 4.3 Soldering Profile

Provided in the table below is the Classification Temperature ( $T_C$ ) of this product and the maximum dwell time the body temperature of this device may be ( $T_C - 5$ )°C or greater. The classification temperature sets the Maximum Body Temperature allowed for this device during lead-free reflow processes. For through-hole devices, and any other processes, the guidelines of J-STD-020 must be observed.

Device	Classification Temperature	Dwell Time	Maximum Reflow Cycles
IX3120G / IX3120GS / IX3120GE / IX3120GES	250°C	30 seconds	3

### 4.4 Board Wash

IXYS Integrated Circuits Division recommends the use of no-clean flux formulations. Board washing to reduce or remove flux residue following the solder reflow process is acceptable provided proper precautions are taken to prevent damage to the device. These precautions include but are not limited to: using a low pressure wash and providing a follow up bake cycle sufficient to remove any moisture trapped within the device due to the washing process. Due to the variability of the wash parameters used to clean the board, determination of the bake temperature and duration necessary to remove the moisture trapped within the package is the responsibility of the user (assembler). Cleaning or drying methods that employ ultrasonic energy may damage the device and should not be used. Additionally, the device must not be exposed to flux or solvents that are Chlorine- or Fluorine-based.



**4.5 Package Mechanical Dimensions**

**4.5.1 IX3120G & IX3120GE 8-Pin DIP**

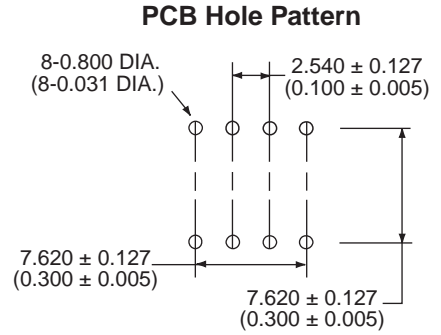
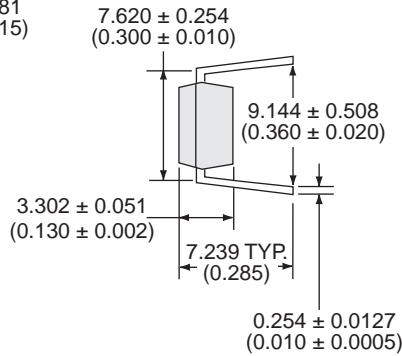
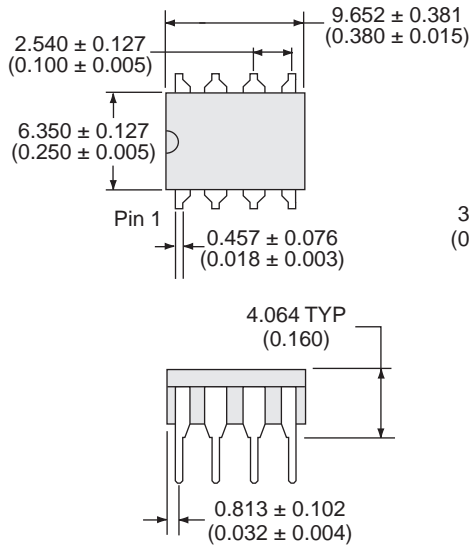

Dimensions  
mm  
(inches)

**4.5.2 IX3120GS & IX3120GES 8-Pin Surface Mount**

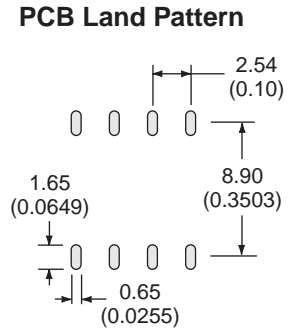
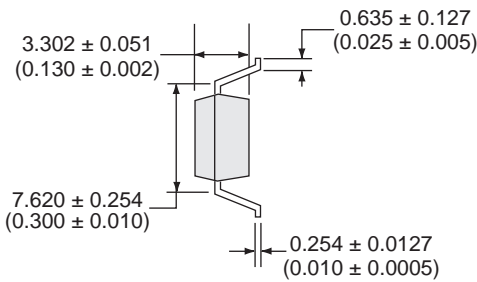
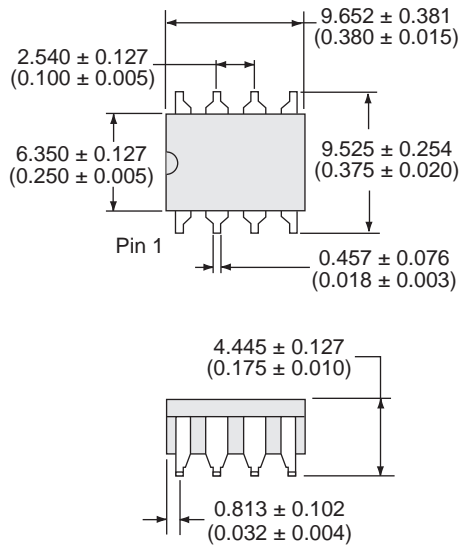

Dimensions  
mm  
(inches)

4.5.3 IX3120GSTR & IX3120GESTR Tape & Reel



4.6 Device Branding



\*YYWW@KKKKK  
 YYWW = date code (year/year/week/week)  
 @KKKKK = sequentially assigned kit code with assembly location identifier

For additional information please visit our website at: [www.ixysic.com](http://www.ixysic.com)

IXYS Integrated Circuits Division makes no representations or warranties with respect to the accuracy or completeness of the contents of this publication and reserves the right to make changes to specifications and product descriptions at any time without notice. Neither circuit patent licenses nor indemnity are expressed or implied. Except as set forth in IXYS Integrated Circuits Division's Standard Terms and Conditions of Sale, IXYS Integrated Circuits Division assumes no liability whatsoever, and disclaims any express or implied warranty, relating to its products including, but not limited to, the implied warranty of merchantability, fitness for a particular purpose, or infringement of any intellectual property right.

The products described in this document are not designed, intended, authorized or warranted for use as components in systems intended for surgical implant into the body, or in other applications intended to support or sustain life, or where malfunction of IXYS Integrated Circuits Division's product may result in direct physical harm, injury, or death to a person or severe property or environmental damage. IXYS Integrated Circuits Division reserves the right to discontinue or make changes to its products at any time without notice.

Specification: DS-IX3120-R06  
 ©Copyright 2017, IXYS Integrated Circuits Division  
 All rights reserved. Printed in USA.  
 8/11/2017