



# Connectors for consumer electronics



## MAS/MAK-series

HiMedia

### Product description

Shielded miniature multipole connectors, 3- pole to 8-pole.

- Numerous different versions ensure a variety of uses in audio- and video equipment, measurement and control instruments, on projectors and in the computer technology

- Safe connection of connector, couplings, panel-mounted sockets and panel-mounted connectors with screw locking system
- All cable connectors feature clamping tabs to relieve the strain
- UM types as standard, but industry package, quantity boxed: 1000 units

### Basic data

Operating voltage: 34 V AC / DC









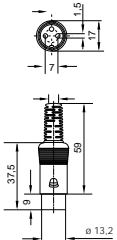

Operating current: 4 A

Flashover voltage: 1 kV

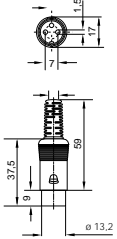
Insulation resistance:  $10^{11} \Omega$

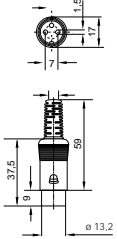
Type of connection: solder

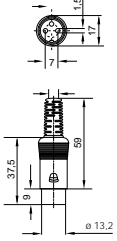
Plug illustrations: EN 60130-9

Type		Number of poles	Description	Colour	Order no.
 MAS 30 MAS 30 UM			Connector with insulated handle, solder connection	grey	<b>930 014-517</b>
				UM black	<b>931 002-100</b>
				UM grey	<b>931 002-117</b>
 MAS 40 MAS 40 UM			Connector with insulated handle, solder connection	grey	<b>930 015-517</b>
				UM grey	<b>931 018-117</b>
 MAS 50 MAS 50 UM			Connector with insulated handle, solder connection	grey	<b>930 016-517</b>
				UM black	<b>931 034-100</b>
				UM grey	<b>931 034-117</b>
 MAS 50 S MAS 50 S UM			Connector with insulated handle, solder connection	black	<b>930 131-500</b>
				grey	<b>930 131-517</b>
				UM black	<b>931 036-100</b>
				UM grey	<b>931 036-117</b>

# Connectors for consumer electronics

## MAS/MAK-series

HiMedia



Type		Number of poles	Description	Colour	Order no.
 MAS 50 W		5	Connector with insulated handle, solder connection	grey	930 805-517
 MAS 60 MAS 60 UM		6	Connector with insulated handle, solder connection	black grey UM black UM grey	930 017-500 930 017-517 931 044-100 931 044-117
 MAS 70 S MAS 70 S UM		7	Connector with insulated handle, solder connection	black grey UM black UM grey	930 356-500 930 356-517 931 050-100 931 050-117
 MAS 80 S MAS 80 S UM		8	Connector with insulated handle, solder connection	black grey UM black UM grey	930 298-500 930 298-517 931 183-100 931 183-117
 MAS 80 SN MAS 80 SN UM		8	Connector with insulated handle, solder connection	black grey black UM grey UM	931 518-500 931 518-517 931 521-100 931 521-117



# Connectors for consumer electronics



## MAS/MAK-series

HiMedia

Type		Number of poles	Description	Colour	Order no.
 <p>MAWI 30 B MAWI 30 B UM</p>		<p>3</p> 	<p>Angled connector with insulated handle, solder connection</p>	<p>grey UM black UM grey</p>	<p>931 597-517 931 621-100 931 621-117</p>
 <p>MAWI 40 B</p>		<p>4</p> 	<p>Angled connector with insulated handle, solder connection</p>	<p>grey</p>	<p>931 567-517</p>
 <p>MAWI 50 B</p>		<p>5</p> 	<p>Angled connector with insulated handle, solder connection</p>	<p>grey</p>	<p>931 569-517</p>
 <p>MAWI 50 SB MAWI 50 SB UM</p>		<p>5</p> 	<p>Angled connector with insulated handle, solder connection</p>	<p>grey UM black UM grey</p>	<p>931 571-517 931 572-100 931 572-117</p>
 <p>MAWI 60 B MAWI 60 B UM</p>		<p>6</p> 	<p>Angled connector with insulated handle, solder connection</p>	<p>grey UM black UM grey</p>	<p>931 573-517 931 574-100 931 574-117</p>

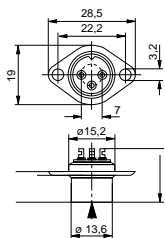
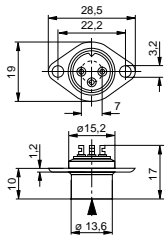
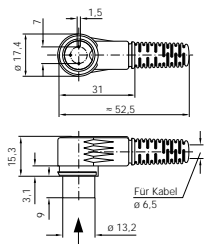
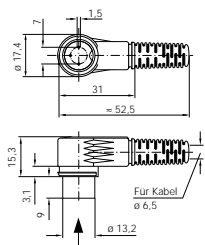
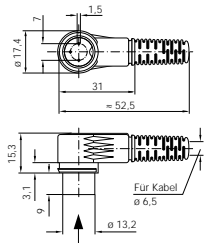



# Connectors for consumer electronics



## MAS/MAK-series

HiMedia

Type		Number of poles	Description	Colour	Order no.
 <p>MAK 30 S MAK 30 S UM</p>		3	Coupling with insulated handle, solder connection	grey UM grey	930 149-517 931 080-117
 <p>MAK 40 MAK 40 UM</p>		4	Coupling with insulated handle, solder connection	grey UM black UM grey	930 150-517 931 086-100 931 086-117
 <p>MAK 50</p>		5	Coupling with insulated handle, solder connection	grey	930 151-517
 <p>MAK 50 S MAK 50 S UM</p>		5	Coupling with insulated handle, solder connection	grey UM black UM grey	930 172-517 931 092-100 931 092-100
 <p>MAK 60 MAK 60 UM</p>		6	Coupling with insulated handle, solder connection	grey UM black	930 152-517 931 100-100

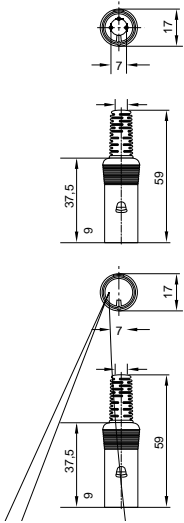





# Connectors for consumer electronics

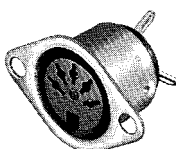
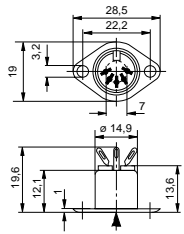

## MAS/MAK-series

HiMedia

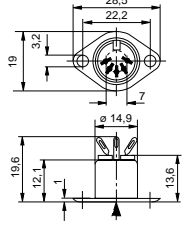
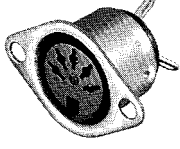
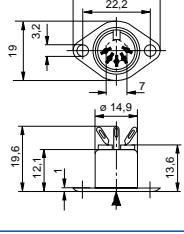
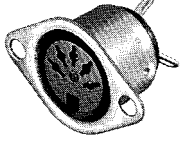
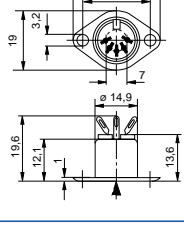
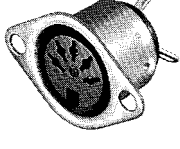
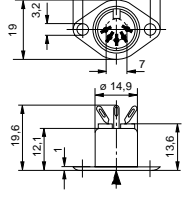
Type		Number of poles	Description	Colour	Order no.
 MAB 5		5	Panel-mounted socket with flange	black	930 010-200
 MAB 5 S		5	Panel-mounted socket with flange	black	930 071-200
 MAB 6		6	Panel-mounted socket with flange	black	930 011-200
 MAB 7 S		7	Panel-mounted socket with flange	black	930 343-200
 MAB 8 S		8	Panel-mounted socket with flange	black	930 345-200

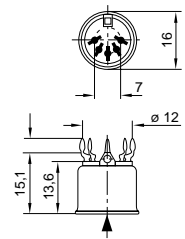
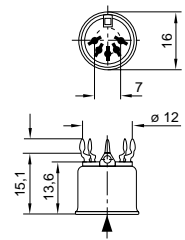
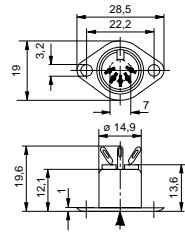



# Connectors for consumer electronics

## MAS/MAK-series

HiMedia

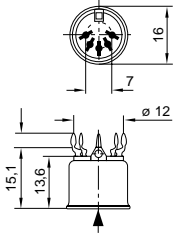
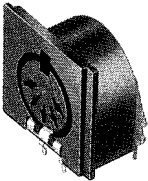
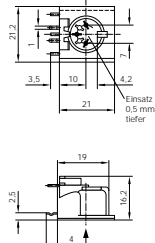
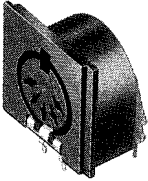
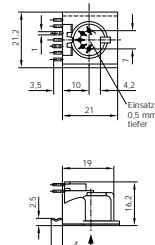
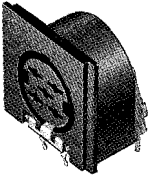
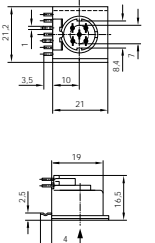
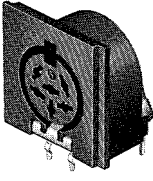
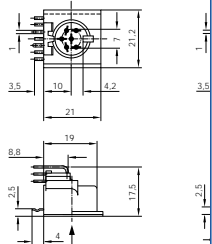
Type		Number of poles	Description	Colour	Order no.
 MAB 8 SV		8	Panel-mounted socket for printed circuits, Plug-in direction perpendicular to the circuit board	black	931 735-200
 MAB 3 SH		3	Panel-mounted socket for printed circuits, Plug-in direction parallel to the circuit board, Board thickness 1,5 mm	black	930 360-200
 MAB 5 SH		5	Panel-mounted socket for printed circuits, Plug-in direction parallel to the circuit board, Board thickness 1,5 mm	black	931 744-200
 MAB 5 WH		5	Panel-mounted socket for printed circuits, Plug-in direction parallel to the circuit board, Board thickness 1,5 mm	black	930 236-200
 MAB 6 H		6	Panel-mounted socket for printed circuits, Plug-in direction parallel to the circuit board, Board thickness 1,5 mm	black	930 778-200

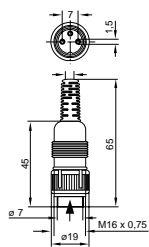
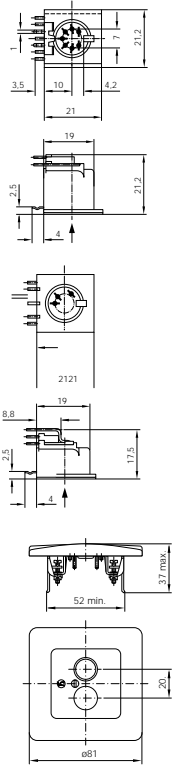









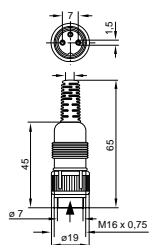

# Connectors for consumer electronics

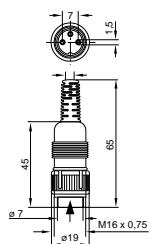

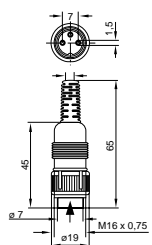
## MAS/MAK-series

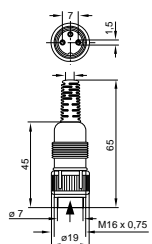
HiMedia

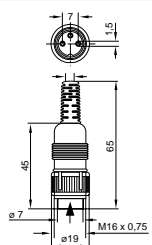

Type		Number of poles	Description	Colour	Order no.
 <p>MAS 4100 MAS 4100 UM</p>		4	Connector with locking screw, solder connection	grey UM black UM grey	930 963-517 931 173-100 931 173-117
 <p>MAS 5100 MAS 5100 UM</p>		5	Connector with locking screw, solder connection	grey UM black UM grey	930 964-517 931 189-100 931 189-117
 <p>MAS 5100 S MAS 5100 S UM</p>		5	Connector with locking screw, solder connection	grey UM grey	930 965-517 931 174-117
 <p>MAS 6100 MAS 6100 UM</p>		6	Connector with locking screw, solder connection	grey UM grey	930 966-517 931 151-117
 <p>MAS 7100 S MAS 7100 S UM</p>		7	Connector with locking screw, solder connection	grey UM grey	930 688-517 930 689-117

# Connectors for consumer electronics

## MAS/MAK-series

HiMedia

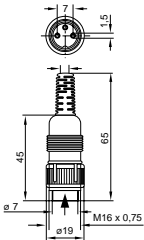

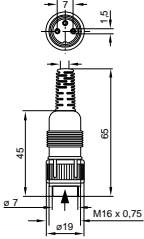
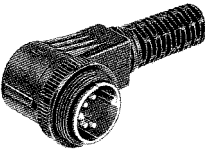
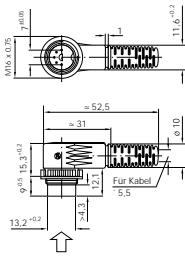
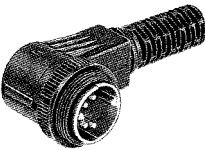
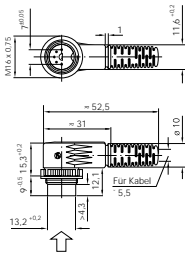
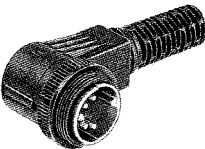
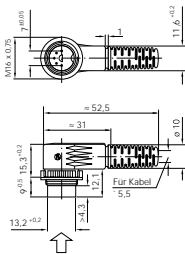
Type		Number of poles	Description	Colour	Order no.
 MAS 8100 S		8	Connector with locking screw, solder connection	grey UM black UM grey	930 539-517 931 240-100 931 240-117
 MAS 8100 SN UM		8	Connector with locking screw, solder connection	UM black UM grey	931 750-100 931 750-117
 MAWI 3100		3	Angled connector with locking screw, solder connection	grey	932 906-117
 MAWI 4100		4	Angled connector with locking screw, solder connection	grey	932 907-117
 MAWI 5100		5	Angled connector with locking screw, solder connection	grey	932 908-117







# Connectors for consumer electronics

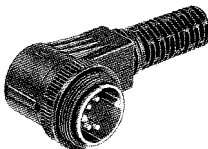
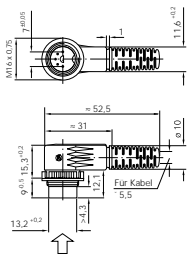
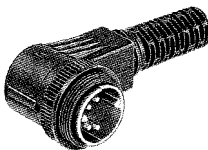
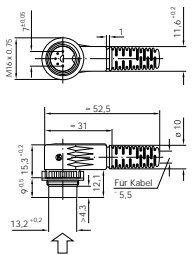
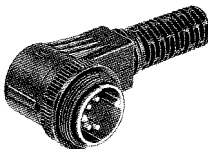
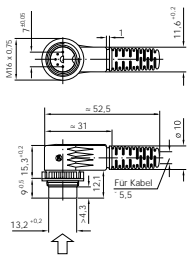

## MAS/MAK-series

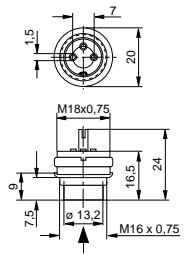
Hi

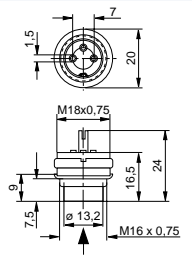
Type		Number of poles	Description	Colour	Order no.
 <p>MAWI 5100 S</p>		5	Angled connector with locking screw, solder connection	grey	932 909-117
 <p>MAWI 6100</p>		6	Angled connector with locking screw, solder connection	grey	932 910-117
 <p>MAWI 8100 S</p>		8	Angled connector with locking screw, solder connection	grey	932 912-117
 <p>MASEI 3100</p>		3	Panel-mounted connector with locking screw, solder connection	grey	930 296-517
 <p>MASEI 4100</p>		4	Panel-mounted connector with locking screw, solder connection	grey	930 955-517

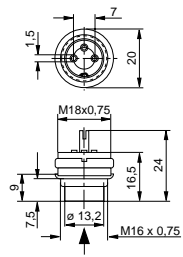

○ 20











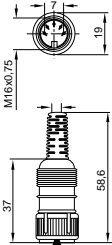

# Connectors for consumer electronics

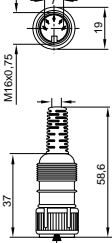

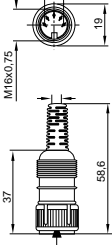
## MAS/MAK-series

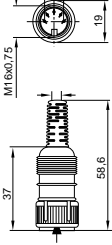
HiMedia

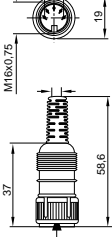





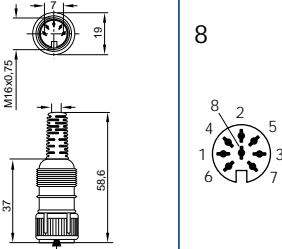

Type		Number of poles	Description	Colour	Order no.
 MAK 5100 MAK 5100 UM		5	Coupling with locking screw, solder connection	grey UM black UM grey	930 960-517 931 176-100 931 176-117
 MAK 5100 S MAK 5100 S UM		5	Coupling with locking screw, solder connection	grey UM black UM grey	930 961-517 931 177-100 931 177-117
 MAK 6100 MAK 6100 UM		6	Coupling with locking screw, solder connection	grey UM grey	930 962-517 931 178-117
 MAK 7100 S MAK 7100 S UM		7	Coupling with locking screw, solder connection	grey UM grey	930 682-517 930 690-117
 MAK 8100 S MAK 8100 S UM		8	Coupling with locking screw, solder connection	grey UM black UM grey	930 538-517 931 127-100 931 127-117

# Connectors for consumer electronics

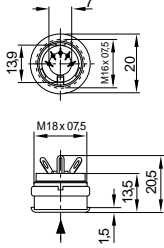

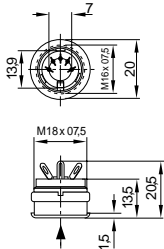

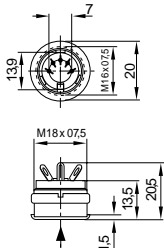

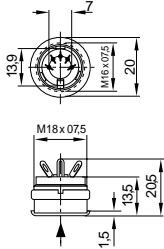

## MAS/MAK-series

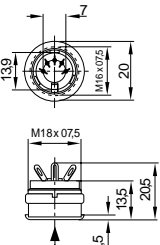
HiMedia

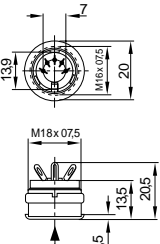

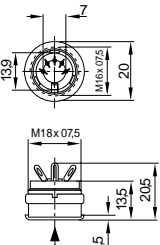
Type		Number of poles	Description	Colour	Order no.
 MAK 8100 SN UM		8	Coupling with locking screw, solder connection	UM black UM grey	931 765-100 931 765-117
 MAB 3100 S		3	Panel-mounted socket with locking screw, solder connection, not shielded	black grey	930 303-500 930 303-517
 MAB 4100		4	Panel-mounted socket with locking screw, solder connection, not shielded	grey	930 951-517
 MAB 5100		5	Panel-mounted socket with locking screw, solder connection, not shielded	grey	930 952-517
 MAB 5100 S		5	Panel-mounted socket with locking screw, solder connection, not shielded	black grey	930 953-500 930 953-517

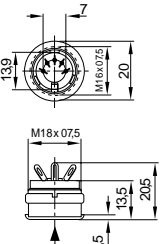

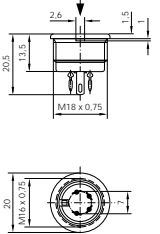







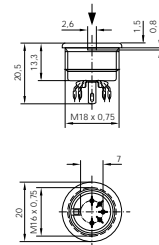

Type		Number of poles	Description	Colour	Order no.
 MAB 6100		6	Panel-mounted socket with locking screw, solder connection, not shielded	black grey	<b>930 954-500</b> <b>930 954-517</b>
 MAB 7100 S		7	Panel-mounted socket with locking screw, solder connection, not shielded	grey	<b>931 351-517</b>
 MAB 8100 S		8	Panel-mounted socket with locking screw, solder connection, not shielded	grey	<b>930 537-517</b>
 MAB 8100 SN		8	Panel-mounted socket with locking screw, solder connection, not shielded	black grey	<b>931 749-500</b> <b>931 749-517</b>
 MAB 4100 V		4	Panel-mounted socket with locking screw, for print assembly, solder connection, not shielded	grey	<b>932 254-517</b>

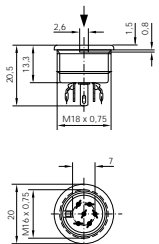
# Connectors for consumer electronics

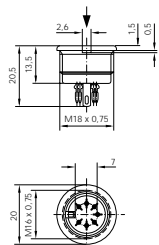
## MAS/MAK-series

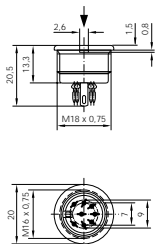
HiMedia

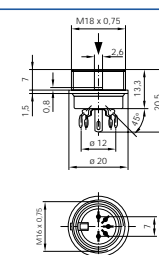

Type		Number of poles	Description	Colour	Order no.	
 MAB 5100 SV		5		Panel-mounted socket with locking screw, for print assembly, solder connection, not shielded	grey	932 201-517
 MAB 6100 V		6		Panel-mounted socket with locking screw, for print assembly, solder connection, not shielded	grey	932 202-517
 MAB 7100 SV		7		Panel-mounted socket with locking screw, for print assembly, solder connection, not shielded	grey	932 423-517
 MAB 8100 SV		8		Panel-mounted socket with locking screw, for print assembly, solder connection, not shielded	grey	932 203-517
 MAB 4500 V		4		Panel-mounted socket with locking screw, for installation in rear panels; max. 4 mm, solder connection, not shielded	grey	933 053-517







# Connectors for consumer electronics

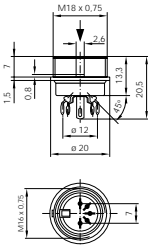

## MAS/MAK-series

HiMedia

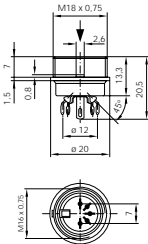
Type		Number of poles	Description	Colour	Order no.
 <p>MAB 5500 SV</p>		5	Panel-mounted socket with locking screw, for installation in rear panels; max. 4 mm, solder connection, not shielded	black grey	932 885-500 932 885-517
 <p>MAB 8500 SV</p>		8	Panel-mounted socket with locking screw, for installation in rear panels; max. 4 mm, solder connection, not shielded	grey	933 141-517
 <p>MAB 8500 SN V</p>		8	Panel-mounted socket with locking screw, for installation in rear panels; max. 4 mm, solder connection, not shielded	grey	933 058-517